

UM12336

POLYBESS1500V1 user manual

Rev. 1.0 — 19 December 2024

User manual

Document information

Information	Content
Keywords	Polycarbonate support, demonstrator, HVBMS, high-voltage battery management system, RD-BESS1500BUN
Abstract	This user manual aims to help users build their POLYBESS1500V1 HVBMS polycarbonate support. This platform is used for BESS1500BUN HVBMS hardware reference design.



1 Kit content

The polycarbonate structure POLYBESS1500V1 for RD-BESS1500BUN kit contains:

Table 1. POLYBESS1500V1 kit contents

Item number	Description	Qty
800-10077	Polycarbonate structure combo of 93915 for top and bottom	1
800-10075	Top stand for 800-10077 / 93915, polycarbonate	1
800-10076	Bottom stand for 800-10077 / 93915, polycarbonate	1
800-76228	Side part 800-89269, polycarbonate, 95 mm hinge	2
800-76232	Side part 800-89269, polycarbonate, 145 mm support frame	2
800-76229	Side part 800-89269, polycarbonate, 50 mm hinge	2
901-10100	HW accessory, fastener package for 800-10077 / 91651	1
280-78008	Fastener, screw M3-.5X25 FH SS	12
280-76979	Screw, flat, M3 X 12 mm, stainless	2
280-78015	Fastener, standoff 3.2 mm ID X 10 mm round female 7 mm OD ABS	8
280-76566	Fastener, nut M3-.5 HEX SS machined	8
280-76355	Screw M3X6 flat MS SS DIN965A	4
280-78013	Fastener, screw M4-.7X14 socket head SS	10
280-78014	Fastener, screw M4-.7X20 socket head SS	2
280-78017	Fastener, wingnut, M4-.7, SS	2
280-76689	Feet, bumpon clear, W 0.620" X H 0.400"	6
600-77772	Cable tie, nylon, 11.5"L, 0.190"W,	2

The tools listed below are required to assemble the structure:





- A Phillips screwdriver
- A 3 mm Allen key
- Pliers
- Cutting pliers

1.1 Content pictures - polycarbonate

Table 2. Polycarbonate structure combo of 93915

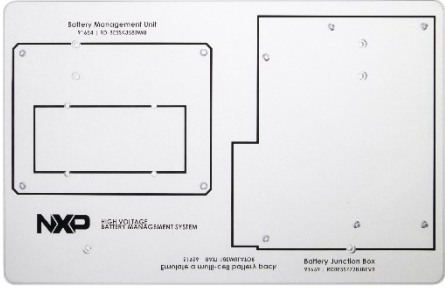
800-10077	Polycarbonate structure combo of 93915 for top and bottom	1
800-10075	Top stand for 800-10077 / 93915, polycarbonate	1
800-10076	Bottom stand for 800-10077 / 93915, polycarbonate	1
800-76228	Side part 800-89269, polycarbonate, 95 mm hinge	2
800-76232	Side part 800-89269, polycarbonate, 145 mm support frame	2
800-76229	Side part 800-89269, polycarbonate, 50 mm hinge	2

Table 3. Content pictures

Top plate (800-10075)	Bottom plate (800-10076)
	
Short hinges, 50 mm (800-76229)	Long hinges, 95 mm (800-76228)
	
Supports, 145 mm (800-76232)	
	

1.2 Content pictures - HW accessory

Table 4. Hardware accessory

901-10100	HW accessory, fastener package for 800-10077 / 91651	1
280-78008	Fastener, screw M3-.5X25 FH SS	12
280-76979	Screw, flat, M3 X 12MM, stainless	2
280-78015	Fastener, standoff, 3.2 mm ID X10 mm round female 7 mm OD ABS	8
280-76566	Fastener, nut M3-.5 hex SS machined	8
280-76355	Screw M3X6 flat MS SS DIN965A	4
280-78013	Fastener, screw M4-.7X14 socket head SS	10
280-78014	Fastener, screw M4-.7X20 socket head SS	2
280-78017	Fastener, wingnut, M4-.7, SS	2
280-76689	Feet, bumpon clear, W 0.620" X H 0.400"	6
600-77772	Cable tie, nylon ,11.5" L,0.190" W,	2



2 Guidelines for the construction of the base structure

This section details the steps for the construction of the base structure.

2.1 Required components

For this part of the construction, the required components are:

Table 5. Required components

Item number	Description	Qty
800-10077	Polycarbonate structure combo of 93915 for top and bottom	1
800-10075	Top stand for 800-10077 / 93915, polycarbonate	1
800-10076	Bottom stand for 800-10077 / 93915, polycarbonate	1
800-76228	Side part 800-89269, polycarbonate, 95 mm hinge	2
800-76232	Side part 800-89269, polycarbonate, 145 mm support frame	2
800-76229	Side part 800-89269, polycarbonate, 50 mm hinge	2
901-10100	HW accessory, fastener package for 800-10077 / 91651	1
280-78013	Fastener, screw M4-.7X14 socket head SS	10
280-78014	Fastener, screw M4-.7X20 socket head SS	2
280-78017	Fastener, wingnut, M4-.7, SS	2
280-76689	Feet, bumpon clear, W 0.620" X H 0.400"	6

2.2 Adding hinges and supports to the top plate

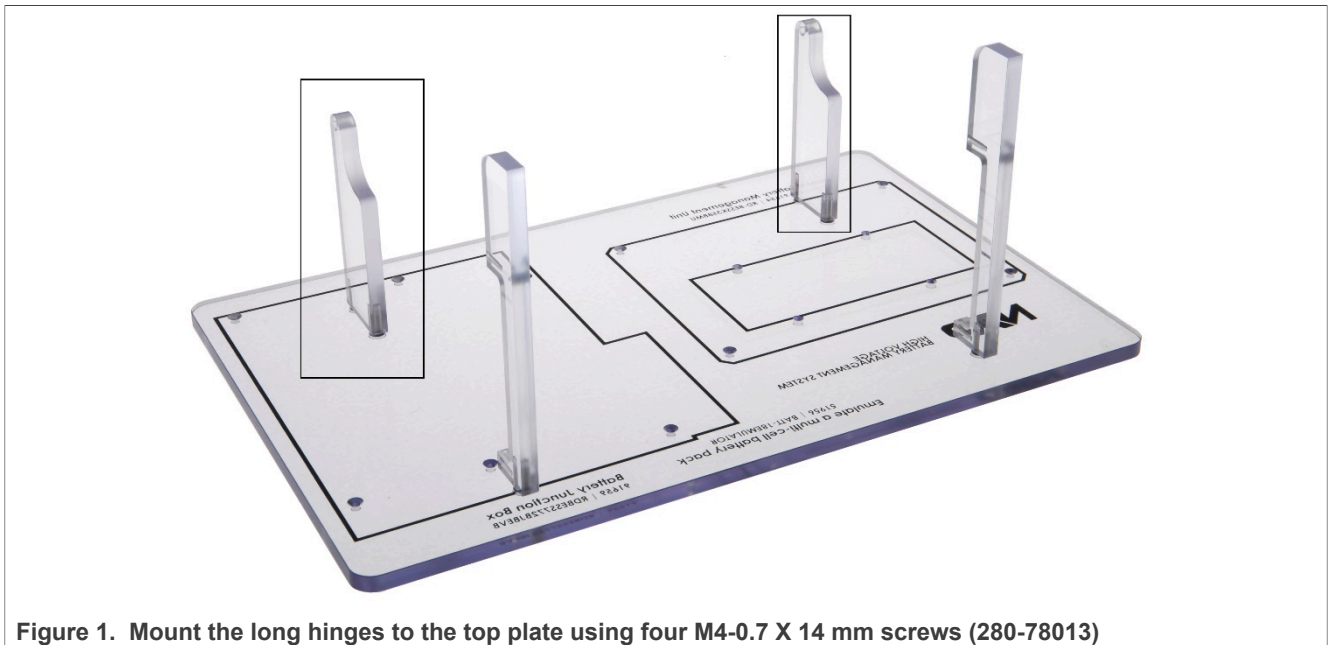

Figure 1. Mount the long hinges to the top plate using four M4-0.7 X 14 mm screws (280-78013)

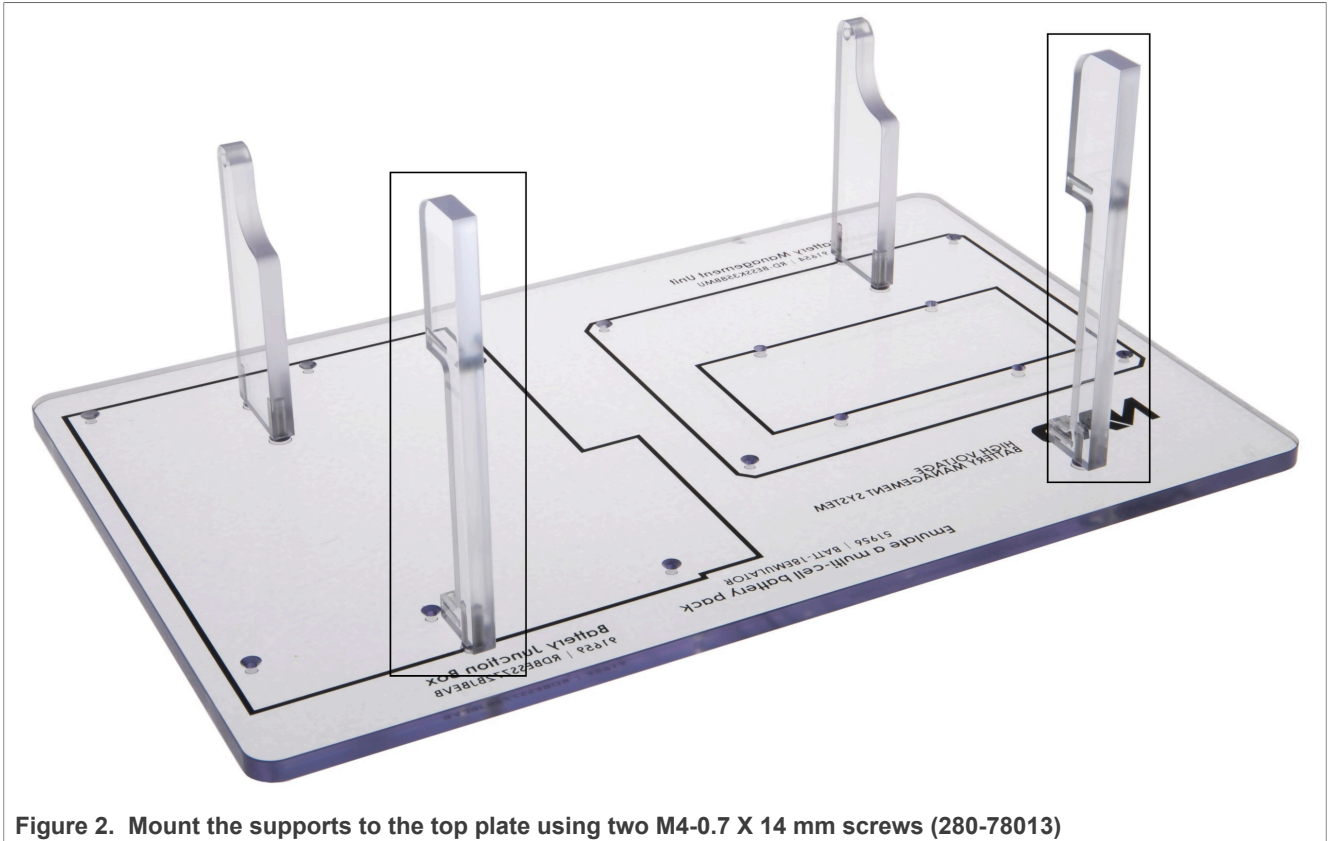

Figure 2. Mount the supports to the top plate using two M4-0.7 X 14 mm screws (280-78013)

2.3 Adding hinges and adhesive feet to the bottom plate

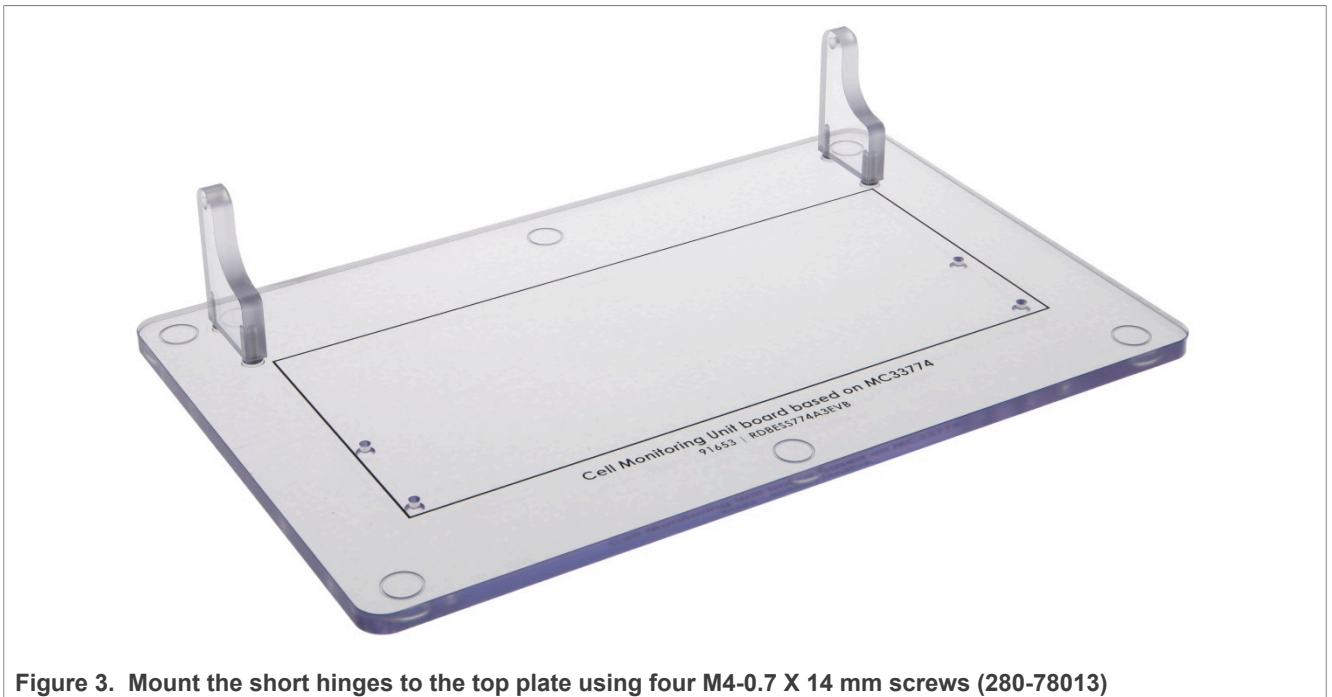

Figure 3. Mount the short hinges to the top plate using four M4-0.7 X 14 mm screws (280-78013)

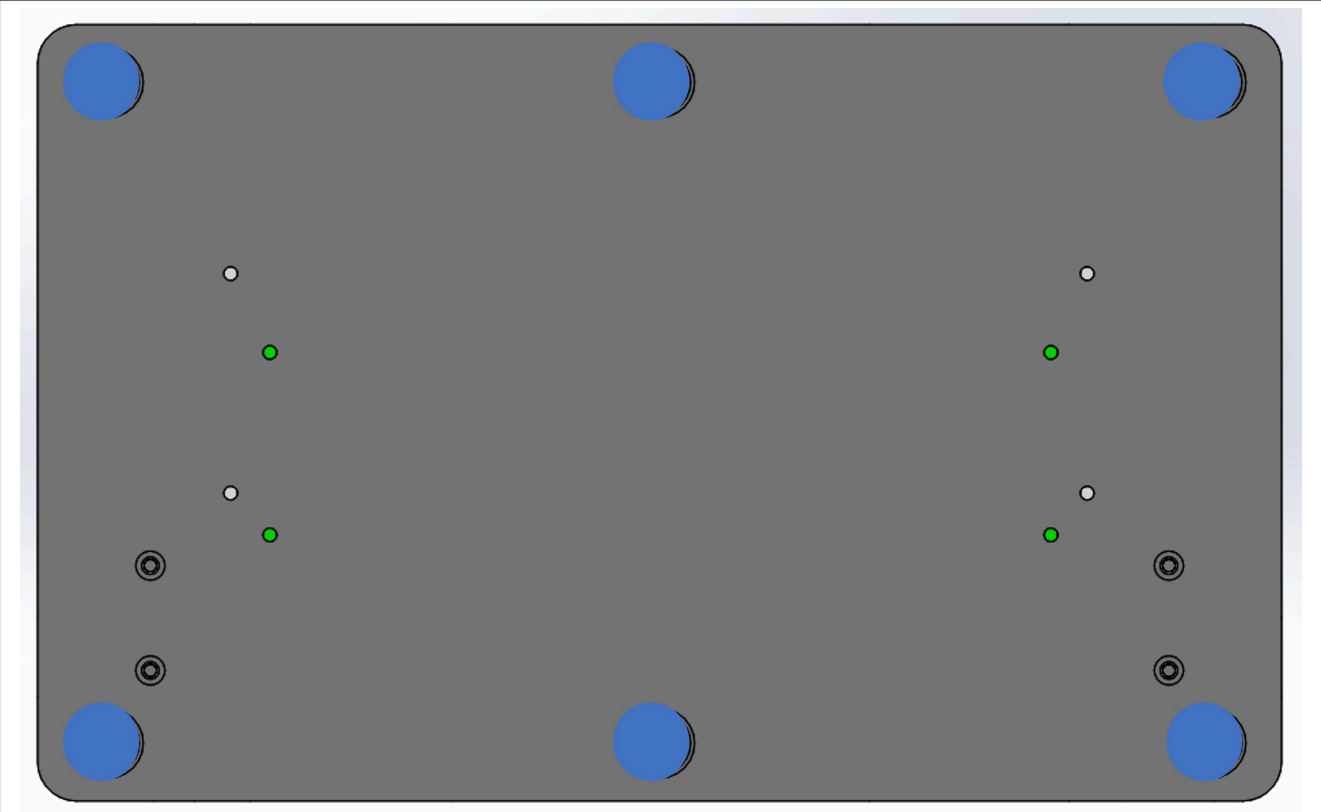

Figure 4. Add the adhesive feet to the bottom plate (280-76689)

2.4 Connecting top and bottom plates



2.5 Completed base structure

The base structure is now complete. To mount the boards on the structure, see [Section 3](#).

3 Guidelines for the specific setup of the RD-BESS1500BUN

This section details the steps for the construction of the specific setup for RD-BESS1500BUN. The RD-BESS1500BUN kit is composed of:

- A RD-BESSK358BMU battery management unit (BMU)
- A RDBESS774A3EVB cell monitoring unit (CMU)
- A RDBESS772BJBEVB battery junction bow (BJB)
- A BATT-18EMULATOR battery emulator
- A 5 V power supply
- A 12 V power supply

Note: One of the two supplies can be fastened to the support.

3.1 Components required

For this part of the construction, the components required are:

1 RD-BESS1500BUN kit

- A RD-BESSK358BMU battery management unit (BMU)
- A RDBESS774A3EVB cell monitoring unit (CMU)
- A RDBESS772BJBEVB battery junction bow (BJB)
- A BATT-18EMULATOR battery emulator
- A 5 V power supply
- A 12V power supply

Table 6. One set of polycarbonate HW accessory

901-10100	HW accessory, fastener package for 800-10077 / 91651	1
280-78008	Fastener, screw M3-.5X25 FH SS	12
280-76979	Screw, flat, M3 X 12 mm, stainless	2
280-78015	Fastener, standoff 3.2 mm ID X 10 mm round female 7 mm OD ABS	8
280-76566	Fastener, nut M3-.5 HEX SS machined	8
280-76355	Screw M3X6 flat MS SS DIN965A	4
280-78013	Fastener, screw M4-.7X14 socket head SS	10
280-78014	Fastener, screw M4-.7X20 socket head SS	2
280-78017	Fastener, wingnut, M4-.7, SS	2
280-76689	Feet, bumpon clear, W 0.620" X H 0.400"	6
600-77772	Cable tie, nylon, 11.5"L, 0.190"W,	2

3.2 Adding support for the battery emulation system

1. Mount both 95 mm side parts (800-76228) using two M4-0.7 X 14 mm screws (280-78013) according to [Figure 1](#) and [Figure 2](#).
2. Mount both 145 mm supports (800-76232) to the top plate using two M4-0.7 X 14 mm screws (280-78013) according to [Figure 1](#) and [Figure 2](#).

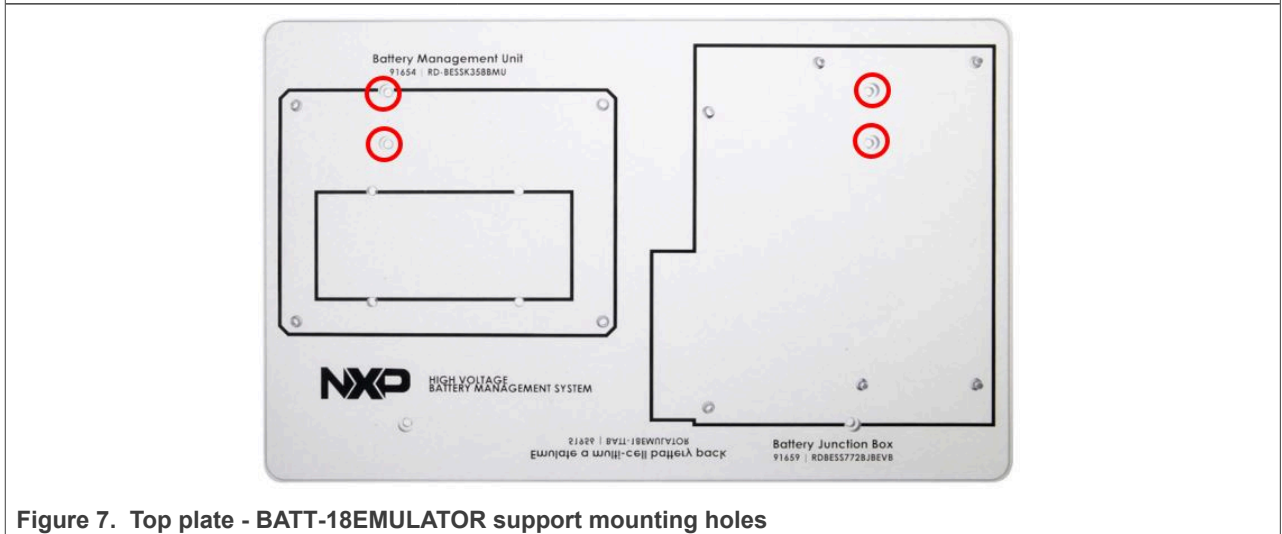
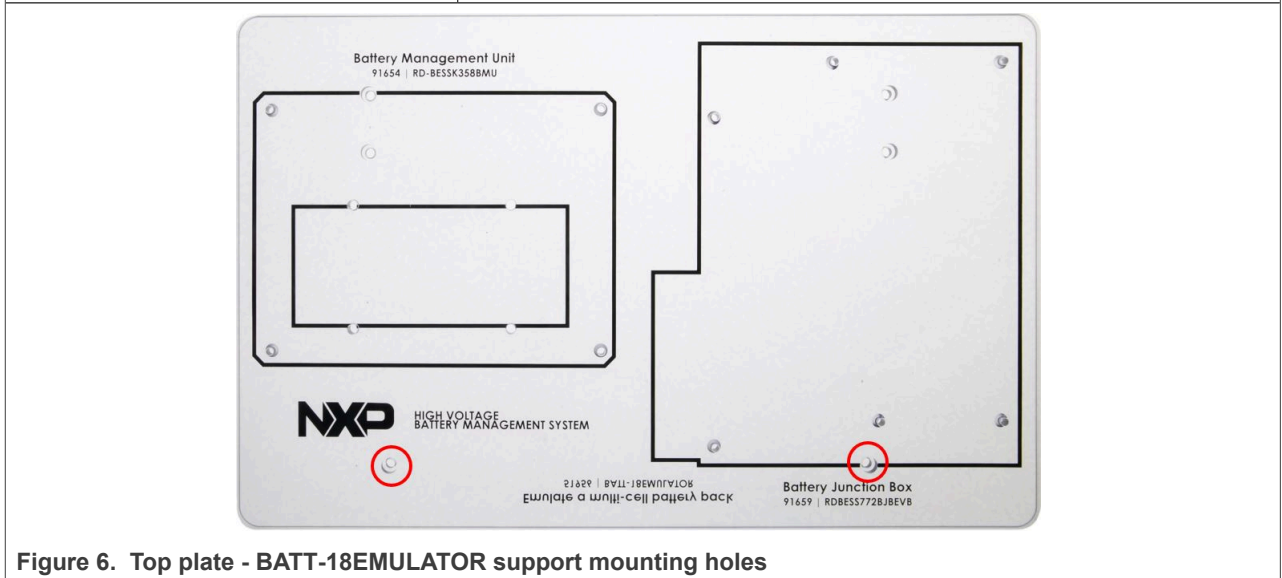
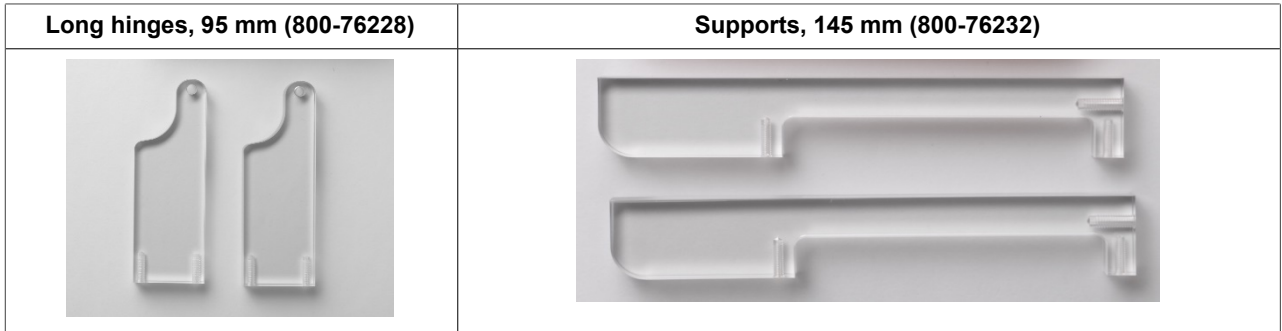

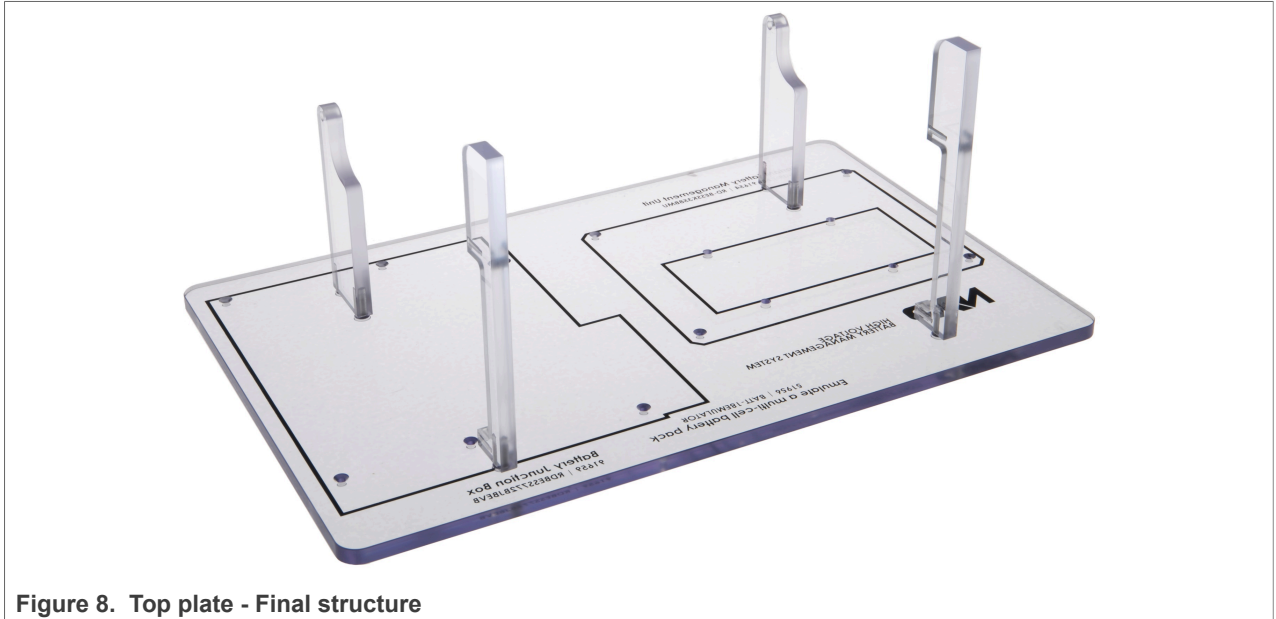

Figure 8. Top plate - Final structure

3. Mount both 50 mm side parts (800-76229) using two using two M4-0.7 X 14 mm screws (280-78013) according to [Figure 3](#) and [Figure 4](#).

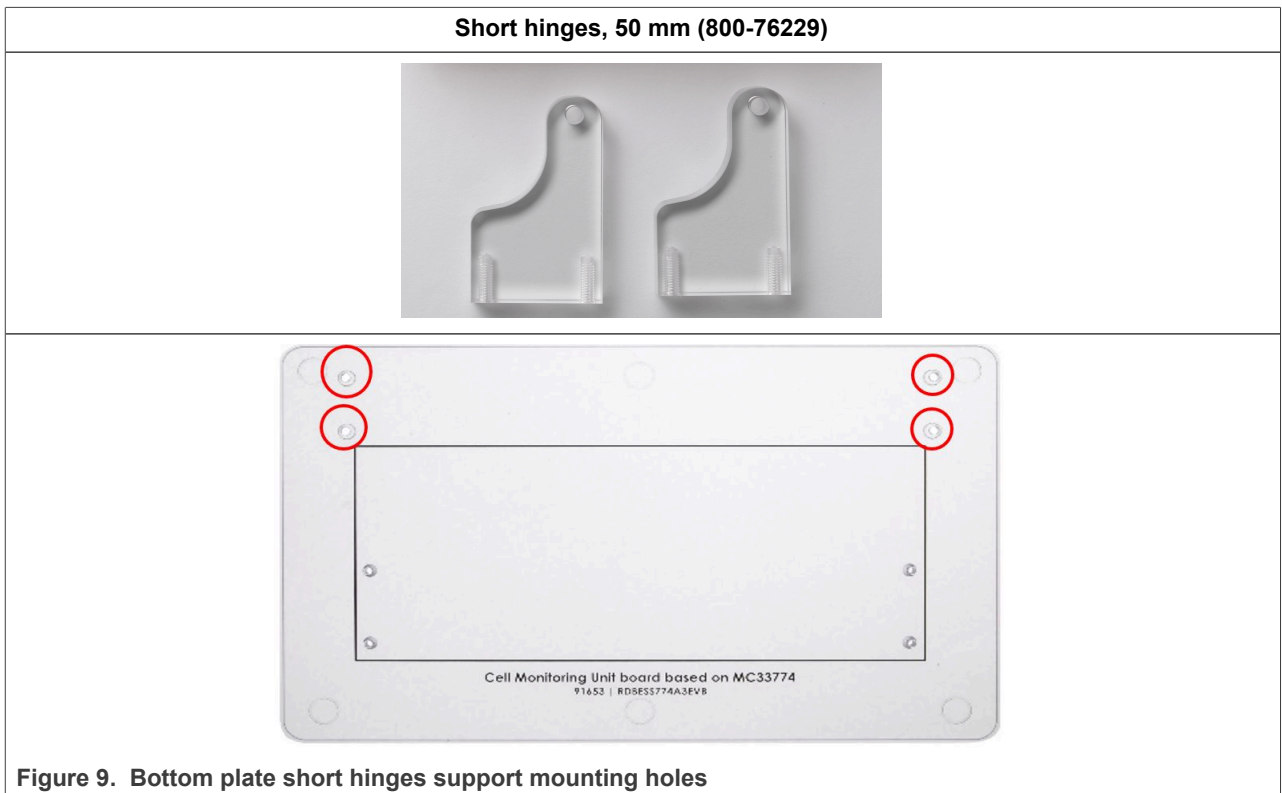

Figure 9. Bottom plate short hinges support mounting holes

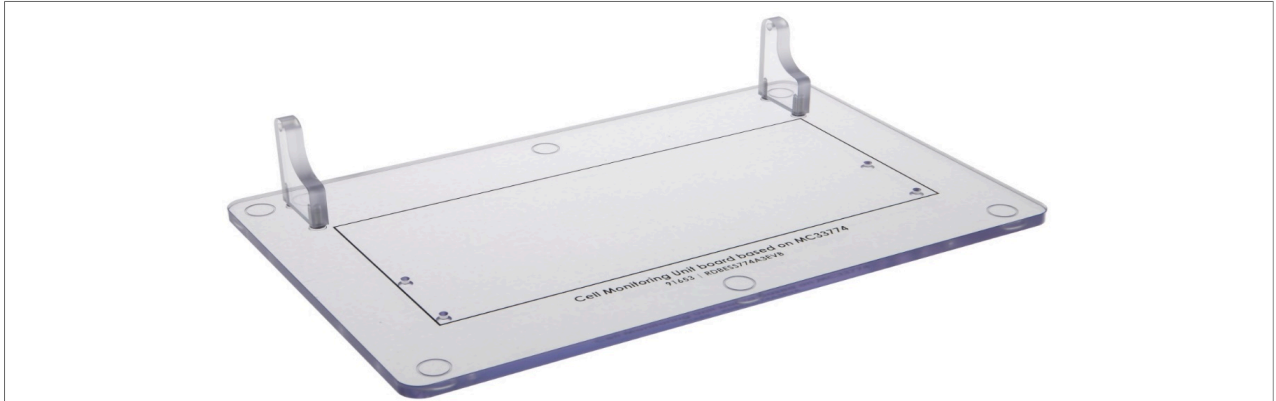

Figure 10. Mount the short hinges to the top plate using four M4-0.7 X 14 mm screws (280-78013)

3.3 Mounting the power supplies (optional)

One of the two power supplies can be fastened on the back of the top plate. The other power supply needs to be placed around the polycarbonate support, but cannot be fastened to it.

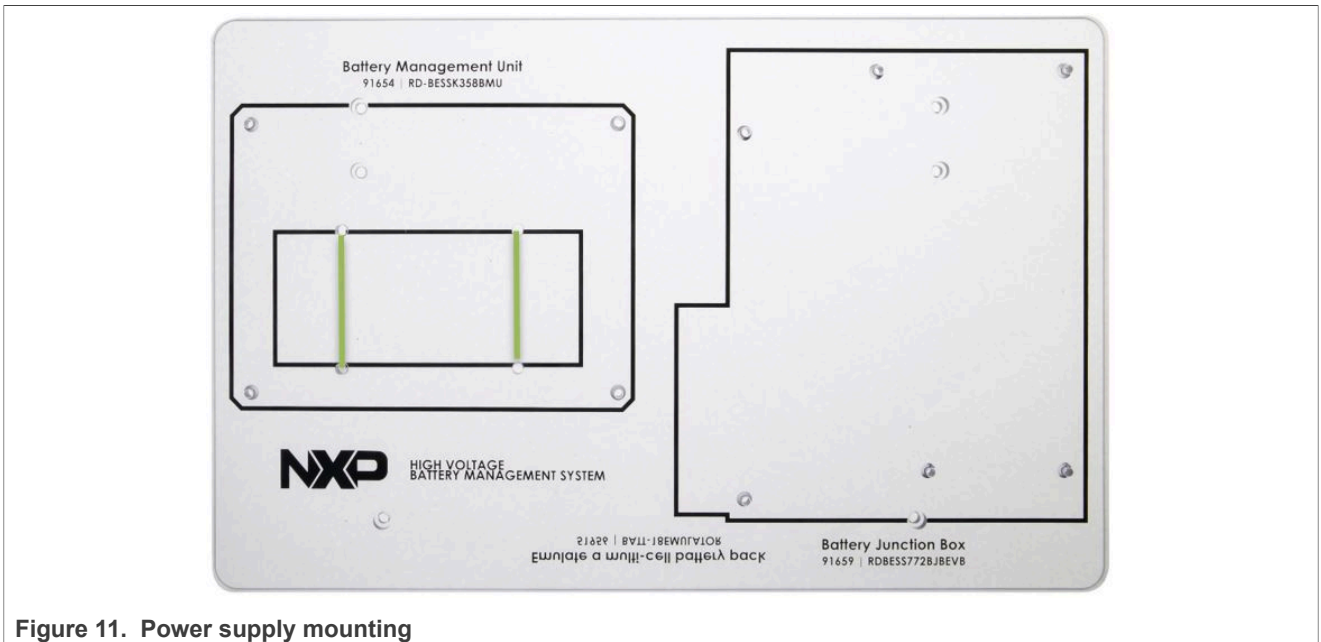

Figure 11. Power supply mounting

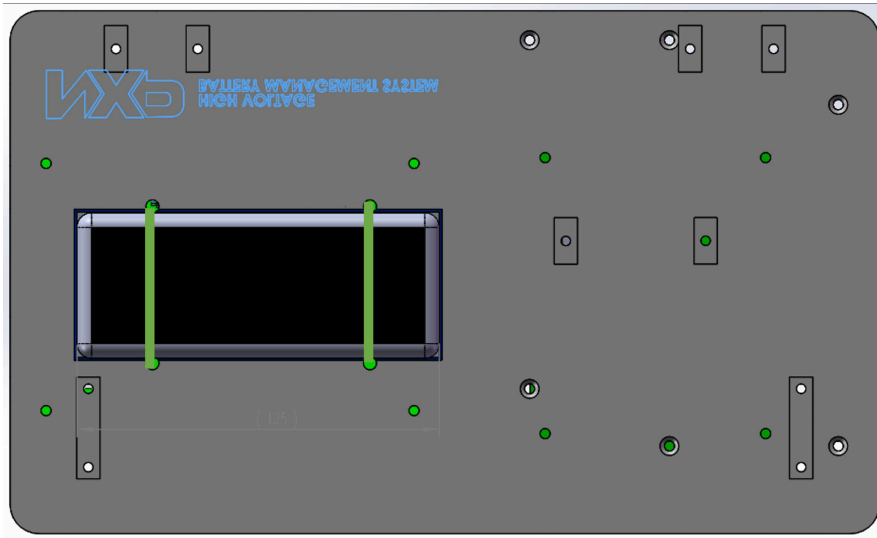

Figure 12. Fastened power supply

Use the two nylon cable ties (600-77772) to fasten one of the power supplies to the top plate according to the highlighted holes. Green marks on [Figure 11](#) and [Figure 12](#).

3.4 Mounting the battery management unit

Mount the BMU to the top plate using four screws (280-78008), four washers (280-78015) and four nuts (280-76566) according to [Figure 13](#).

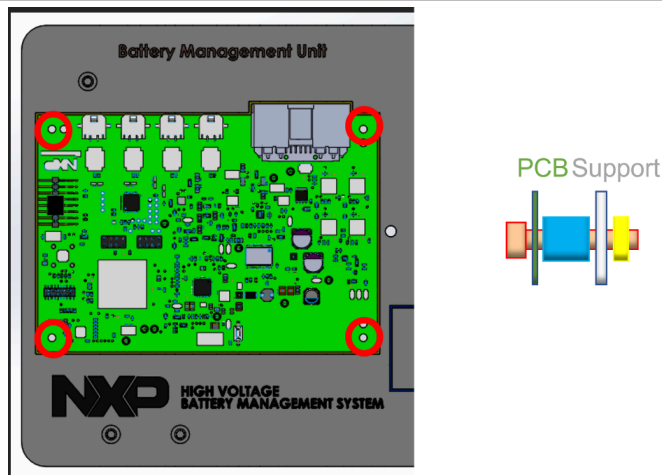

Figure 13. Battery management unit mounting procedure

3.5 Mounting the cell monitoring unit

Mount the CMU to the bottom plate using four screws (280-78008), four washers (280-78015) and four nuts (280-76566) according to [Figure 14](#).

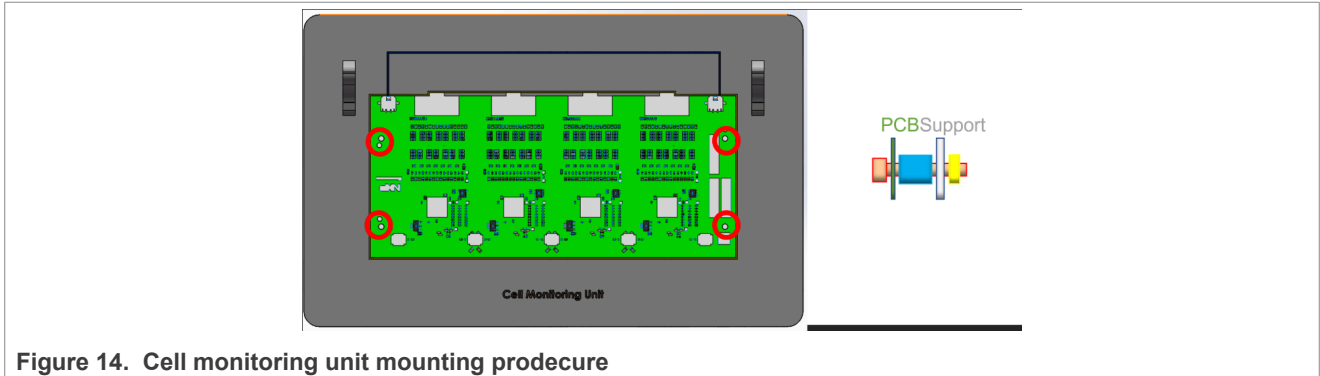

Figure 14. Cell monitoring unit mounting procedure

3.6 Mounting the battery junction box

Mount the BJB to the top plate using four screws (280-78008), four washers (280-78015), and four nuts (280-76566) according to [Figure 15](#) and [Figure 16](#).

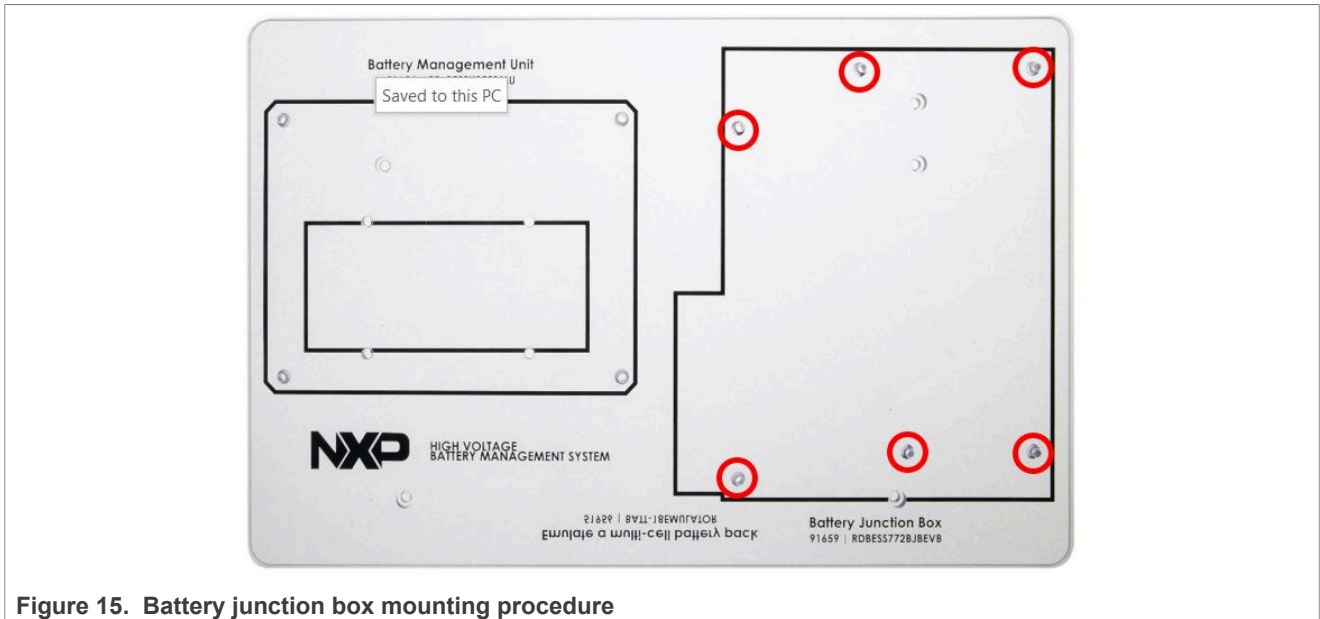

Figure 15. Battery junction box mounting procedure

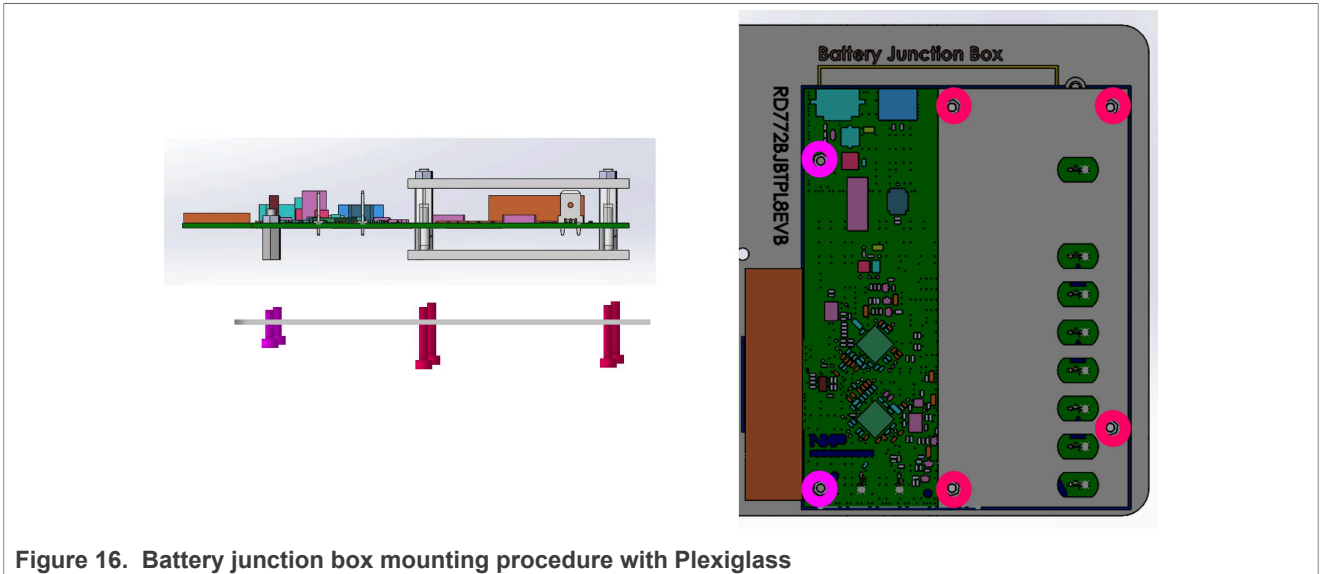

Figure 16. Battery junction box mounting procedure with Plexiglass

3.7 Mounting the battery emulation system

Mount the battery emulator to the 78 mm side parts using four screws (280-76355) according to [Figure 17](#).

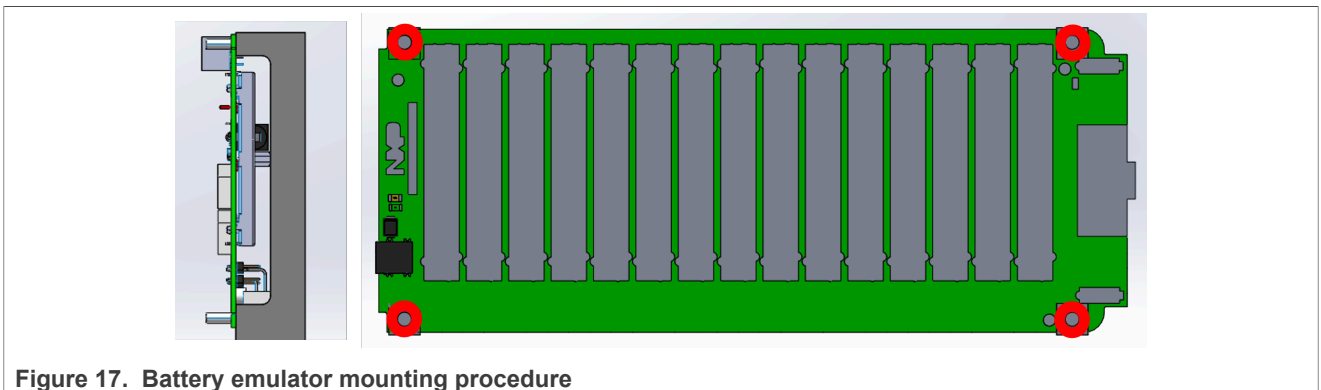

Figure 17. Battery emulator mounting procedure

Note: The J1 connector should face the right side.

3.8 Connect the top and bottom plates

Connect the top and bottom plates using two M4-0.7 X 20 mm screws (280-78014) and two wingnuts (280-78017).



Figure 18. Connect the top and bottom plates

3.9 Completed structure

The RD-BESS1500BUN structure is now complete. To learn how to connect the boards together, refer to the reference design [user manual](#) available on the RD-BESS1500BUN web page.

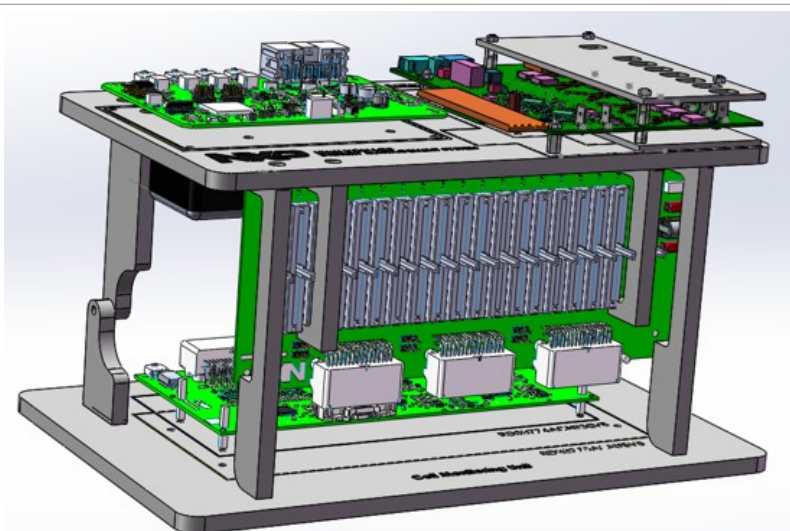

Figure 19. Final structure for RD-BESS1500BUN

4 References

- [1] **RD-BESS1500BUN — 1500 V Battery Energy Storage Reference Design** — detailed information on the RD-BESS1500 BUN, <https://www.nxp.com/part/RD-BESS1500BUN>

5 Revision history

Table 7. Revision history

Document ID	Release date	Description
UM12336 v.1	19 December 2024	Initial version

Legal information

Definitions

Draft — A draft status on a document indicates that the content is still under internal review and subject to formal approval, which may result in modifications or additions. NXP Semiconductors does not give any representations or warranties as to the accuracy or completeness of information included in a draft version of a document and shall have no liability for the consequences of use of such information.

Disclaimers

Limited warranty and liability — Information in this document is believed to be accurate and reliable. However, NXP Semiconductors does not give any representations or warranties, expressed or implied, as to the accuracy or completeness of such information and shall have no liability for the consequences of use of such information. NXP Semiconductors takes no responsibility for the content in this document if provided by an information source outside of NXP Semiconductors.

In no event shall NXP Semiconductors be liable for any indirect, incidental, punitive, special or consequential damages (including - without limitation - lost profits, lost savings, business interruption, costs related to the removal or replacement of any products or rework charges) whether or not such damages are based on tort (including negligence), warranty, breach of contract or any other legal theory.

Notwithstanding any damages that customer might incur for any reason whatsoever, NXP Semiconductors' aggregate and cumulative liability towards customer for the products described herein shall be limited in accordance with the Terms and conditions of commercial sale of NXP Semiconductors.

Right to make changes — NXP Semiconductors reserves the right to make changes to information published in this document, including without limitation specifications and product descriptions, at any time and without notice. This document supersedes and replaces all information supplied prior to the publication hereof.

Applications — Applications that are described herein for any of these products are for illustrative purposes only. NXP Semiconductors makes no representation or warranty that such applications will be suitable for the specified use without further testing or modification.

Customers are responsible for the design and operation of their applications and products using NXP Semiconductors products, and NXP Semiconductors accepts no liability for any assistance with applications or customer product design. It is customer's sole responsibility to determine whether the NXP Semiconductors product is suitable and fit for the customer's applications and products planned, as well as for the planned application and use of customer's third party customer(s). Customers should provide appropriate design and operating safeguards to minimize the risks associated with their applications and products.

NXP Semiconductors does not accept any liability related to any default, damage, costs or problem which is based on any weakness or default in the customer's applications or products, or the application or use by customer's third party customer(s). Customer is responsible for doing all necessary testing for the customer's applications and products using NXP Semiconductors products in order to avoid a default of the applications and the products or of the application or use by customer's third party customer(s). NXP does not accept any liability in this respect.

Terms and conditions of commercial sale — NXP Semiconductors products are sold subject to the general terms and conditions of commercial sale, as published at <https://www.nxp.com/profile/terms>, unless otherwise agreed in a valid written individual agreement. In case an individual agreement is concluded only the terms and conditions of the respective agreement shall apply. NXP Semiconductors hereby expressly objects to applying the customer's general terms and conditions with regard to the purchase of NXP Semiconductors products by customer.

Suitability for use in automotive applications — This NXP product has been qualified for use in automotive applications. If this product is used by customer in the development of, or for incorporation into, products or services (a) used in safety critical applications or (b) in which failure could lead to death, personal injury, or severe physical or environmental damage (such products and services hereinafter referred to as "Critical Applications"), then customer makes the ultimate design decisions regarding its products and is solely responsible for compliance with all legal, regulatory, safety, and security related requirements concerning its products, regardless of any information or support that may be provided by NXP. As such, customer assumes all risk related to use of any products in Critical Applications and NXP and its suppliers shall not be liable for any such use by customer. Accordingly, customer will indemnify and hold NXP harmless from any claims, liabilities, damages and associated costs and expenses (including attorneys' fees) that NXP may incur related to customer's incorporation of any product in a Critical Application.

Export control — This document as well as the item(s) described herein may be subject to export control regulations. Export might require a prior authorization from competent authorities.

HTML publications — An HTML version, if available, of this document is provided as a courtesy. Definitive information is contained in the applicable document in PDF format. If there is a discrepancy between the HTML document and the PDF document, the PDF document has priority.

Translations — A non-English (translated) version of a document, including the legal information in that document, is for reference only. The English version shall prevail in case of any discrepancy between the translated and English versions.

Security — Customer understands that all NXP products may be subject to unidentified vulnerabilities or may support established security standards or specifications with known limitations. Customer is responsible for the design and operation of its applications and products throughout their lifecycles to reduce the effect of these vulnerabilities on customer's applications and products. Customer's responsibility also extends to other open and/or proprietary technologies supported by NXP products for use in customer's applications. NXP accepts no liability for any vulnerability. Customer should regularly check security updates from NXP and follow up appropriately. Customer shall select products with security features that best meet rules, regulations, and standards of the intended application and make the ultimate design decisions regarding its products and is solely responsible for compliance with all legal, regulatory, and security related requirements concerning its products, regardless of any information or support that may be provided by NXP.

NXP has a Product Security Incident Response Team (PSIRT) (reachable at PSIRT@nxp.com) that manages the investigation, reporting, and solution release to security vulnerabilities of NXP products.

NXP B.V. — NXP B.V. is not an operating company and it does not distribute or sell products.

Trademarks

Notice: All referenced brands, product names, service names, and trademarks are the property of their respective owners.

NXP — wordmark and logo are trademarks of NXP B.V.

Tables

Tab. 1.	POLYBESS1500V1 kit contents	2	Tab. 5.	Required components	5
Tab. 2.	Polycarbonate structure combo of 93915	3	Tab. 6.	One set of polycarbonate HW accessory	9
Tab. 3.	Content pictures	3	Tab. 7.	Revision history	19
Tab. 4.	Hardware accessory	4			

Figures

Fig. 1.	Mount the long hinges to the top plate using four M4-0.7 X 14 mm screws (280-78013)5	Fig. 8.	Top plate - Final structure 11
Fig. 2.	Mount the supports to the top plate using two M4-0.7 X 14 mm screws (280-78013)6	Fig. 9.	Bottom plate short hinges support mounting holes 11
Fig. 3.	Mount the short hinges to the top plate using four M4-0.7 X 14 mm screws (280-78013)6	Fig. 10.	Mount the short hinges to the top plate using four M4-0.7 X 14 mm screws (280-78013) 12
Fig. 4.	Add the adhesive feet to the bottom plate (280-76689)7	Fig. 11.	Power supply mounting 12
Fig. 5.	Connect the top and bottom plates using two M4-0.7 X 20 mm screws (280-78014) and two wingnuts (280-78017)8	Fig. 12.	Fastened power supply 13
Fig. 6.	Top plate - BATT-18EMULATOR support mounting holes 10	Fig. 13.	Battery management unit mounting procedure 13
Fig. 7.	Top plate - BATT-18EMULATOR support mounting holes 10	Fig. 14.	Cell monitoring unit mounting prodecure 14
		Fig. 15.	Battery junction box mounting procedure 14
		Fig. 16.	Battery junction box mounting procedure with Plexiglass 15
		Fig. 17.	Battery emulator mounting procedure 15
		Fig. 18.	Connect the top and bottom plates 16
		Fig. 19.	Final structure for RD-BESS1500BUN 17

Contents

1	Kit content	2
1.1	Content pictures - polycarbonate	3
1.2	Content pictures - HW accessory	4
2	Guidelines for the construction of the base structure	5
2.1	Required components	5
2.2	Adding hinges and supports to the top plate	5
2.3	Adding hinges and adhesive feet to the bottom plate	6
2.4	Connecting top and bottom plates	8
2.5	Completed base structure	8
3	Guidelines for the specific setup of the RD-BESS1500BUN	9
3.1	Components required	9
3.2	Adding support for the battery emulation system	10
3.3	Mounting the power supplies (optional)	12
3.4	Mounting the battery management unit	13
3.5	Mounting the cell monitoring unit	14
3.6	Mounting the battery junction box	14
3.7	Mounting the battery emulation system	15
3.8	Connect the top and bottom plates	16
3.9	Completed structure	17
4	References	18
5	Revision history	19
	Legal information	20

Please be aware that important notices concerning this document and the product(s) described herein, have been included in section 'Legal information'.
