

NOTE: The theory in this application note is still applicable, but some of the products referenced may be discontinued.

**AN1107**

# Understanding RF Data Sheet Parameters

Prepared by: **Norman E. Dye**  
 RF Products Division

## INTRODUCTION

Data sheets are often the sole source of information about the capability and characteristics of a product. This is particularly true of unique RF semiconductor devices that are used by equipment designers all over the world. Because the circuit designer often cannot talk directly with the factory, he relies on the data sheet for his device information. And for RF devices, many of the specifications are unique in themselves. Thus it is important that the user and the manufacturer of RF products speak a common language, i.e., what the semiconductor manufacturer says about his RF device is understood fully by the circuit designer.

This paper reviews RF transistor and amplifier module parameters from maximum ratings to functional characteristics. It is divided into 5 basic sections: 1) DC Specifications, 2) Power Transistors, 3) Low Power Transistors, 4) Power Modules and 5) Linear Modules. Comments are made about critical specifications, about how values are determined and what are their significance. A brief description of the procedures used to obtain impedance data and thermal data is set forth; the importance of test circuits is elaborated; and background information is given to help understand low noise considerations and linearity requirements.

## DC SPECIFICATIONS

Basically RF transistors are characterized by two types of parameters: DC and functional. The "DC" specs consist (by definition) of breakdown voltages, leakage currents,  $h_{FE}$  (DC beta) and capacitances, while the functional specs cover gain, ruggedness, noise figure,  $Z_{in}$  and  $Z_{out}$ , S-parameters, distortion, etc. Thermal characteristics do not fall cleanly into either category since thermal resistance and power dissipation can be either DC or AC. Thus, we will treat the spec of thermal resistance as a special specification and give it its own heading called "thermal characteristics." Figure 1 is one page of a typical RF power data sheet showing DC and functional specs.

A critical part of selecting a transistor is choosing one that has breakdown voltages compatible with the supply voltage available in an intended application. It is important that the design engineer select a transistor on the one hand that has breakdown voltages which will NOT be exceeded by the DC and RF voltages that appear across the various junctions

of the transistor and on the other hand has breakdown voltages that permit the "gain at frequency" objectives to be met by the transistor. Mobile radios normally operate from a 12 volt source; portable radios use a lower voltage, typically 6 to 9 volts; avionics applications are commonly 28 volt supplies while base station and other ground applications such as medical electronics generally take advantage of the superior performance characteristics of high voltage devices and operate with 24 to 50 volt supplies. In making a transistor, breakdown voltages are largely determined by material resistivity and junction depths (Figure 2). It is for these reasons that breakdown voltages are intimately entwined with functional performance characteristics. Most product portfolios in the RF power transistor industry have families of transistors designed for use at specified supply voltages such as 7.5 volts, 12.5 volts, 28 volts and 50 volts.

*Leakage currents* (defined as reverse biased junction currents that occur prior to avalanche breakdown) are likely to be more varied in their specification and also more informative. Many transistors do not have leakage currents specified because they can result in excessive (and frequently unnecessary) wafer/die yield losses. Leakage currents arise as a result of material defects, mask imperfections and/or undesired impurities that enter during wafer processing. Some sources of leakage currents are potential reliability problems; most are not. Leakage currents can be material related such as stacking faults and dislocations or they can be "pipes" created by mask defects and/or processing inadequacies. These sources result in leakage currents that are constant with time and if initially acceptable for a particular application will remain so. They do not pose long term reliability problems.

On the other hand, leakage currents created by channels induced by mobile ionic contaminants in the oxide (primarily sodium) tend to change with time and can lead to increases in leakage current that render the device useless for a specific application. Distinguishing between sources of leakage current can be difficult, which is one reason devices for application in military environments require HTRB (high temperature reverse bias) and burn-in testing. However, even for commercial applications particularly where battery drain is critical or where bias considerations dictate limitations, it is essential that a leakage current limit be included in any complete device specification.



ELECTRICAL CHARACTERISTICS (T <sub>C</sub> = 25°C unless otherwise noted.)					
Characteristic	Symbol	Min	Typ	Max	Unit
<b>OFF CHARACTERISTICS</b>					
Collector–Emitter Breakdown Voltage (I <sub>C</sub> = 20 mAdc, I <sub>B</sub> = 0)	V <sub>(BR)CEO</sub>	16	—	—	Vdc
Collector–Emitter Breakdown Voltage (I <sub>C</sub> = 20 mAdc, V <sub>BE</sub> = 0)	V <sub>(BR)CES</sub>	36	—	—	Vdc
Emitter–Base Breakdown Voltage (I <sub>E</sub> = 5.0 mAdc, I <sub>C</sub> = 0)	V <sub>(BR)EBO</sub>	4.0	—	—	Vdc
Collector Cutoff Current (V <sub>CE</sub> = 15 Vdc, V <sub>BE</sub> = 0, T <sub>C</sub> = 25°C)	I <sub>CES</sub>	—	—	10	mAdc
<b>ON CHARACTERISTICS</b>					
DC Current Gain (I <sub>C</sub> = 4.0 Adc, V <sub>CE</sub> = 5.0 Vdc)	h <sub>FE</sub>	20	70	150	—
<b>DYNAMIC CHARACTERISTICS</b>					
Output Capacitance (V <sub>CB</sub> = 12.5 Vdc, I <sub>E</sub> = 0, f = 1.0 MHz)	C <sub>ob</sub>	—	90	125	pF
<b>FUNCTIONAL TESTS</b>					
Common–Emitter Amplifier Power Gain (V <sub>CC</sub> = 12.5 Vdc, P <sub>out</sub> = 45 W, I <sub>C</sub> (Max) = 5.8 Adc, f = 470 MHz)	G <sub>pe</sub>	4.8	5.4	—	dB
Input Power (V <sub>CC</sub> = 12.5 Vdc, P <sub>out</sub> = 45 W, f = 470 MHz)	P <sub>in</sub>	—	13	15	Watts
Collector Efficiency (V <sub>CC</sub> = 12.5 Vdc, P <sub>out</sub> = 45 W, I <sub>C</sub> (Max) = 5.8 Adc, f = 470 MHz)	η	55	60	—	%
Load Mismatch Stress (V <sub>CC</sub> = 16 Vdc, P <sub>in</sub> = Note 1, f = 470 MHz, VSWR = 20:1, All Phase Angles)	ψ*	No Degradation in Output Power			
Series Equivalent Input Impedance (V <sub>CC</sub> = 12.5 Vdc, P <sub>out</sub> = 45 W, f = 470 MHz)	Z <sub>in</sub>	—	1.4+j4.0	—	Ohms
Series Equivalent Output Impedance (V <sub>CC</sub> = 12.5 Vdc, P <sub>out</sub> = 45 W, f = 470 MHz)	Z <sub>OL</sub> *	—	1.2+j2.8	—	Ohms

NOTES:

- P<sub>in</sub> = 150% of Drive Requirement for 45 W output @ 12.5 V.  
 \* ψ = Mismatch stress factor — the electrical criterion established to verify the device resistance to load mismatch failure. The mismatch stress test is accomplished in a standard test fixture terminated in a 20:1 minimum load mismatch at all phase angles.

Figure 1. Typical DC and Functional Specifications

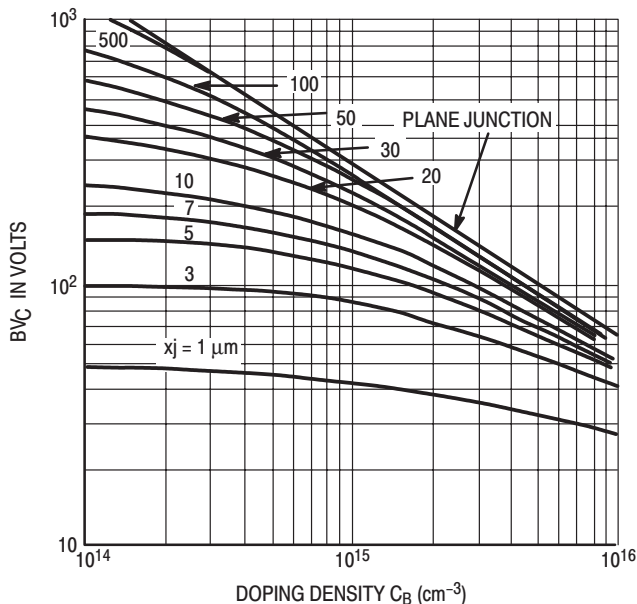

Figure 2. The Effect of Curvature and Resistivity on Breakdown Voltage

DC parameters such as  $h_{FE}$  and  $C_{ob}$  (output capacitance) need little comment. Typically, for RF devices,  $h_{FE}$  is relatively unimportant for unbiased power transistors because the functional parameter of gain at the desired frequency of operation is specified. Note, though, that DC beta is related to AC beta (Figure 3). Functional gain will track DC beta particularly at lower RF frequencies. An  $h_{FE}$  specification is needed for transistors that require bias, which includes most small signal devices that are normally operated in a linear (Class A) mode. Generally RF device manufacturers do not like to have tight limits placed on  $h_{FE}$ . Primarily the reasons that justify this position are:

- a) Lack of correlation with RF performance
- b) Difficulty in control in wafer processing
- c) Other device manufacturing constraints dictated by functional performance specs which preclude tight limits for  $h_{FE}$ .

A good rule of thumb for  $h_{FE}$  is to set a maximum-to-minimum ratio of not less than 3 and not more than 4 with the minimum  $h_{FE}$  value determined by an acceptable margin in functional gain.

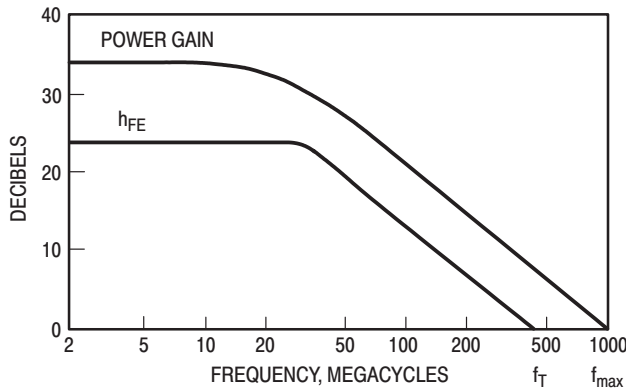

Figure 3. Beta versus Frequency

*Output capacitance* is an excellent measure of comparison of device size (base area) provided the majority of output capacitance is created by the base-collector junction and not parasitic capacitance arising from bond pads and other top metal of the die. Remember that junction capacitance will vary with voltage (Figure 4) while parasitic capacitance will not vary. Also, in comparing devices, one should note the voltage at which a given capacitance is specified. No industry standard exists. The preferred voltage at Motorola is the transistor  $V_{CC}$  rating, i.e., 12.5 volts for 12.5 volt transistors and 28 volts for 28 volt transistors, etc.

**MAXIMUM RATINGS AND THERMAL CHARACTERISTICS**

Maximum ratings (shown for a typical RF power transistor in Figure 5) tend to be the most frequently misunderstood group of device specifications. Ratings for *maximum junction voltages* are straight forward and simply reflect the minimum values set forth in the DC specs for breakdown voltages. If the device in question meets the specified minimum breakdown voltages, then voltages less than the minimum

will not cause junctions to reach reverse bias breakdown with the potentially destructive current levels that can result.

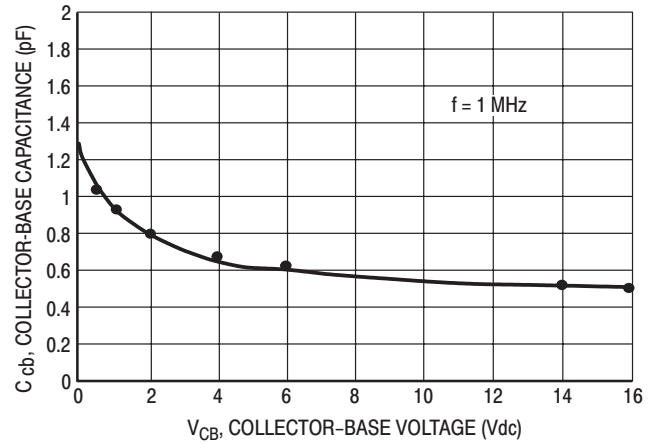

Figure 4. Junction Capacitance versus Voltage

The value of  $V_{(BR)CEO}$  is sometimes misunderstood. Its value can approach or even equal the supply voltage rating of the transistor. The question naturally arises as to how such a low voltage can be used in practical applications. First,  $V_{(BR)CEO}$  is the breakdown voltage of the collector-base junction plus the forward drop across the base-emitter junction with the base open, and it is never encountered in amplifiers where the base is at or near the potential of the emitter. That is to say, most amplifiers have the base shorted or they use a low value of resistance such that the breakdown value of interest approaches  $V_{(BR)CES}$ . Second,  $V_{(BR)CEO}$  involves the current gain of the transistor and increases as frequency increases. Thus the value of  $V_{(BR)CEO}$  at RF frequencies is always greater than the value at DC.

The maximum rating for *power dissipation* ( $P_D$ ) is closely associated with thermal resistance ( $\theta_{JC}$ ). Actually maximum  $P_D$  is in reality a fictitious number — a kind of figure of merit — because it is based on the assumption that case temperature is maintained at 25°C. However, providing everyone arrives at the value in a similar manner, the rating of maximum  $P_D$  is a useful tool with which to compare devices.

The rating begins with a determination of thermal resistance — die to case. Knowing  $\theta_{JC}$  and assuming a maximum die temperature, one can easily determine maximum  $P_D$  (based on the previously stated case temperature of 25°C). Measuring  $\theta_{JC}$  is normally done by monitoring case temperature ( $T_C$ ) of the device while it operates at or near rated output power ( $P_O$ ) in an RF circuit. The die temperature ( $T_J$ ) is measured simultaneously using an infra-red microscope (see Figure 6) which has a spot size resolution as small as 1 mil in diameter. Normally several readings are taken over the surface of the die and an average value is used to specify  $T_J$ .

It is true that temperatures over a die will vary typically 10–20°C. A poorly designed die (improper ballasting) could result in hot spot (worst case) temperatures that vary 40–50°C. Likewise, poor die bonds (see Figure 7) can result in hot spots but these are not normal characteristics of a properly designed and assembled transistor die.

# The RF Line

## NPN Silicon

### RF Power Transistor

**MRF650**

**50 WATTS, 512 MHz**  
**RF POWER TRANSISTOR**  
**NPN SILICON**

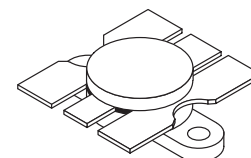

**CASE 316-01**

... designed for 12.5 Volt UHF large-signal amplifier applications in industrial and commercial FM equipment operating to 520 MHz.

- Guaranteed 440, 470, 512 MHz 12.5 Volt Characteristics
  - Output Power = 50 Watts
  - Minimum Gain = 5.2 dB @ 440, 470 MHz
  - Efficiency = 55% @ 440, 470 MHz
  - IRL = 10 dB
- Characterized with Series Equivalent Large-Signal Impedance Parameters from 400 to 520 MHz
- Built-In Matching Network for Broadband Operation
- Triple Ion Implanted for More Consistent Characteristics
- Implanted Emitter Ballast Resistors
- Silicon Nitride Passivated
- 100% Tested for Load Mismatch Stress at all Phase Angles with 20:1 VSWR @ 15.5 Vdc, 2.0 dB Overdrive

MAXIMUM RATINGS			
Rating	Symbol	Value	Unit
Collector-Emitter Voltage	$V_{CEO}$	16.5	Vdc
Collector-Emitter Voltage	$V_{CES}$	38	Vdc
Emitter-Base Voltage	$V_{EBO}$	4.0	Vdc
Collector-Current — Continuous	$I_C$	12	Adc
Total Device Dissipation @ $T_C = 25^\circ\text{C}$ Derate above $25^\circ\text{C}$	$P_D$	135 0.77	Watts $\text{W}/^\circ\text{C}$
Storage Temperature Range	$T_{stg}$	-65 to +150	$^\circ\text{C}$
THERMAL CHARACTERISTICS			
Characteristic	Symbol	Max	Unit
Thermal Resistance, Junction to Case	$R_{\theta JC}$	1.3	$^\circ\text{C}/\text{W}$

**Figure 5. Maximum Ratings of a Typical RF Power Transistor**

By measuring  $T_C$  and  $T_J$  along with  $P_O$  and  $P_{in}$  — both DC and RF — one can calculate  $\theta_{JC}$  from the formula  $\theta_{JC} = (T_J - T_C)/(P_{in} - P_O)$ . Typical values for an RF power transistor might be  $T_J = 130^\circ\text{C}$ ;  $T_C = 50^\circ\text{C}$ ;  $V_{CC} = 12.5\text{ V}$ ;  $I_C = 9.6\text{ A}$ ;  $P_{in}(\text{RF}) = 10\text{ W}$ ;  $P_O(\text{RF}) = 50\text{ W}$ . Thus  $\theta_{JC} = (130 - 50)/(10 + \{12.5 \times 9.6\} - 30) = 80/80 = 1^\circ\text{C}/\text{W}$ .

Several reasons dictate a conservative value be placed on  $\theta_{JC}$ . First, thermal resistance increases with temperature (and we realize  $T_C = 25^\circ\text{C}$  is NOT realistic). Second,  $T_J$  is not a worst case number. And, third, by using a conservative value of  $\theta_{JC}$ , a realistic value is determined for maximum  $P_D$ . Generally, Motorola's practice is to publish  $\theta_{JC}$  numbers

approximately 25% higher than that determined by the measurements described in the preceding paragraphs, or for the case illustrated, a value of  $\theta_{JC} = 1.25^\circ\text{C}/\text{W}$ .

Now a few words are in order about die temperature. Reliability considerations dictate a safe value for an all Au (gold) system (die top metal and wire) to be  $200^\circ\text{C}$ . Once  $T_J \text{ max}$  is determined, along with a value for  $\theta_{JC}$ , maximum  $P_D$  is simply

$$P_D(\text{max}) = (T_J(\text{max}) - 25^\circ\text{C})/\theta_{JC}$$

Specifying maximum  $P_D$  for  $T_C = 25^\circ\text{C}$  leads to the necessity to derate maximum  $P_D$  for any value of  $T_C$  above  $25^\circ\text{C}$ . The derating factor is simply the reciprocal of  $\theta_{JC}$ !

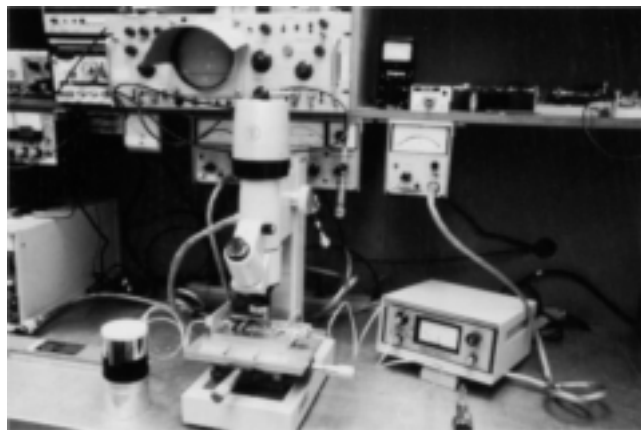

**Figure 6. Equipment Used To Measure Die Temperature**

Maximum collector current ( $I_C$ ) is probably the most subjective maximum rating on transistor data sheets. It has been, and is, determined in a number of ways each leading to different maximum values. Actually, the only valid maximum current limitations in an RF transistor have to do with the current handling ability of the wires or the die. However, power dissipation ratings may restrict current to values far below what should be the maximum rating. Unfortunately, many older transistors had their maximum current rating determined by dividing maximum  $P_D$  by collector voltage (or be  $V_{(BR)CEO}$  for added safety) but this is not a fundamental maximum current limitation of the part. Many lower frequency parts have relatively gross top metal on the transistor die, i.e., wide metal runners and the “weak current link” in the part is the current handling capability of the emitter wires (for common emitter parts). The current handling ability of wire (various sizes and material) is well known; thus the maximum current rating may be limited by the number, size and material used for emitter wires.

Most modern, high frequency transistors are die limited because of high current densities resulting from very small current carrying conductors and these densities can lead to metal migration and premature failure. The determination of  $I_C$  max for these types of transistors results from use of Black's equation for metal migration which determines a mean time between failures (MTBF) based on current density, temperature and type of metal. At Motorola, MTBF is generally set at >7 years and maximum die temperature at 200°C. For plastic packaged transistors, maximum  $T_J$  is set at 150°C. The resulting current density along with a knowledge of the die geometry and top metal thickness and material allows the determination of  $I_C$  max for the device.

It is up to the transistor manufacturer to specify an  $I_C$  max based on which of the two limitations (die, wire) is paramount. It is recommended that the circuit design engineer consult the semiconductor manufacturer for additional information if  $I_C$  max is of any concern in his specific use of the transistor.

Storage temperature is another maximum rating that is frequently not given the attention it deserves. A range of -55°C to 200°C has become more or less an industry standard. And for the single metal, hermetic packaged type

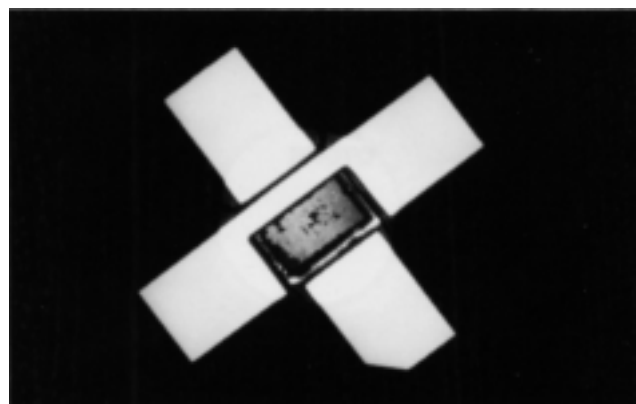

**Figure 7. An Example of Incomplete Die Attach**

of device, the upper limit of 200°C creates no reliability problems. However, a lower high temperature limitation exists for plastic encapsulated or epoxy sealed devices. These should not be subjected to temperatures above 150°C to prevent deterioration of the plastic material.

### **POWER TRANSISTORS — Functional Characteristics**

The selection of a power transistor usually involves choosing one for a frequency of operation, a level of output power, a desired gain, a voltage of operation and preferred package configuration consistent with circuit construction techniques.

Functional characteristics of an RF power transistor are by necessity tied to a specific test circuit (an example is shown in Figure 8). Without specifying a circuit, the functional parameters of gain, reflected power, efficiency — even ruggedness — hold little meaning. Furthermore, most test circuits used by RF transistor manufacturers today (even those used to characterize devices) are designed mechanically to allow for easy insertion and removal of the device under test (D.U.T.). This mechanical restriction sometimes limits achievable device performance which explains why performance by users frequently exceeds that indicated in data sheet curves. On the other hand, a circuit used to characterize a device is usually narrow band and tunable. This results in higher gain than attainable in a broadband circuit. Unless otherwise stated, it can be assumed that characterization data such as  $P_O$  vs frequency is generated on a point-by-point basis by tuning a narrow band circuit across a band of frequencies and, thus, represents what can be achieved at a specific frequency of interest provided the circuit presents optimum source and load impedances to the D.U.T.

Broadband, fixed tuned test circuits are the most desirable for testing functional performance of an RF transistor. Fixed tuned is particularly important in assuring everyone — the manufacturer and the user — of product consistency, i.e., that devices manufactured tomorrow will be identical to devices manufactured today.

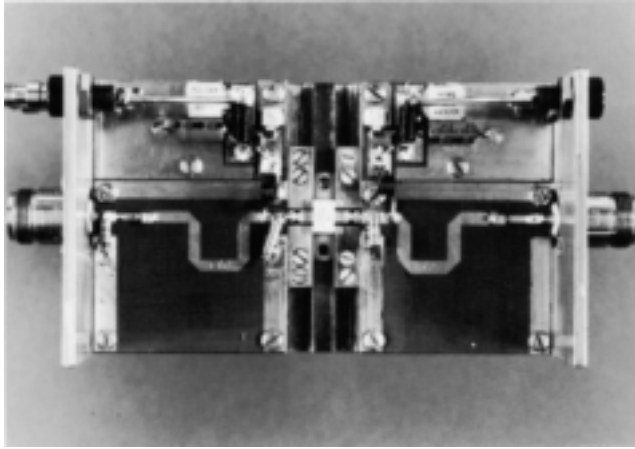

Figure 8. Typical RF Power Test Circuit

Tunable, narrow band circuits have led to the necessity for device users and device manufacturers to resort to the use of “correlation units” to assure product consistency over a period of time. Fixed tuned circuits minimize (if not eliminate) the requirements for correlation and in so doing tend to compensate for the increased constraints they place on the device manufacturer. On the other hand, manufacturers like tunable test circuits because their use allows adjustments that can compensate for variations in die fabrication and/or device assembly. Unfortunately gain is normally less in a broadband circuit than it is in a narrow band circuit, and this fact frequently forces transistor manufacturers to use narrow band circuits to make their product have sufficient attraction when compared with other similar devices made by competitors. This is called “specsmanship.” One compromise for the transistor manufacturer is to use narrow band circuits with all tuning adjustments “locked” in place. For all of the above reasons, then, in comparing functional parameters of two or more devices, the data sheet reader should observe carefully the test circuit in which specific parameter limits are guaranteed.

For RF power transistors, the parameter of ruggedness takes on considerable importance. Ruggedness is the characteristic of a transistor to withstand extreme mismatch conditions in operation (which causes large amounts of output power to be “dumped back” into the transistor) without altering its performance capability or reliability. Many circuit environments particularly portable and mobile radios have limited control over the impedance presented to the power amplifier by an antenna, at least for some duration of time. In portables, the antenna may be placed against a metal surface; in mobiles, perhaps the antenna is broken off or inadvertently disconnected from the radio. Today’s RF power transistor must be able to survive such load mismatches without any effect on subsequent operation. A truly realistic possibility for mobile radio transistors (although not a normal situation) is the condition whereby an RF power device “sees” a worst case load mismatch (an open circuit, any phase angle) along with maximum  $V_{CC}$  AND greater than normal input drive — all at the same time. Thus the ultimate test for ruggedness is to subject a transistor to a test wherein  $P_{in}$  (RF) is increased up to 50% above that value necessary to create rated  $P_{O}$ ;  $V_{CC}$  is increased about 25% (12.5 V to 16 V for mobile transistors) AND then the load reflection coefficient is set at a magnitude of unity while its phase angle

is varied through all possible values from 0 degrees to 360 degrees. Many 12 volt (land mobile) transistors are routinely given this test at Motorola Semiconductors by means of a test station similar to the one shown in Figure 9.



Figure 9. Typical Functional Test Station

Ruggedness specifications come in many forms (or guises). Many older devices (and even some newer ones) simply have NO ruggedness spec. Others are said to be “capable of” withstanding load mismatches. Still others are guaranteed to withstand load mismatches of 2:1 VSWR to  $\infty$ :1 VSWR at rated output power. A few truly rugged transistors are guaranteed to withstand 30:1 VSWR at all phase angles (for all practical purposes 30:1 VSWR is the same as  $\infty$ :1 VSWR) with both over voltage and over drive. Once again it is up to the user to match his circuit requirements against device specifications.

Then as if the whole subject of ruggedness is not sufficiently confusing, the semiconductor manufacture slips in the ultimate “muddy the water” condition in stating what constitutes passing the ruggedness test. The words generally say that after the ruggedness test the D.U.T. “shall have no degradation in output power.” A better phrase would be “no measurable change in output power.” But even this is not the best. Unfortunately the D.U.T. can be “damaged” by the ruggedness test and still have “no degradation in output power.” Today’s RF power transistors consist of up to 1K or more low power transistors connected in parallel. Emitter resistors are placed in series with groups of these transistors in order to better control power sharing throughout the transistor die. It is well known by semiconductor manufacturers that a high percentage of an RF power transistor die (say up to 25–30%) can be destroyed with the transistor still able to deliver rated power at rated gain, at least for some period of time. If a ruggedness test destroys a high percentage of cells in a transistor, then it is likely that a 2nd ruggedness test (by the manufacturer or by the user while in his circuit) would result in additional damage leading to premature device failure.

A more scientific measurement of “passing” or “failing” a ruggedness test is called  $\Delta V_{RE}$  — the change in emitter resistance before and after the ruggedness test.  $V_{RE}$  is determined to a large extent by the net value of emitter resistance in the transistor die. Thus if cells are destroyed, emitter resistance will change with a resultant change in  $V_{RE}$ . Changes as small as 1% are readily detectable, with 5% or

less normally considered an acceptable limit. Today's more sophisticated device specifications for RF power transistors use this criteria to determine "success" or "failure" in ruggedness testing.

A circuit designer must know the input/output characteristics of the RF power transistor(s) he has selected in order to design a circuit that "matches" the transistor over the frequency band of operation. Data sheets provide this information in the form of large signal impedance parameters,  $Z_{in}$  and  $Z_{out}$  (commonly referred to as  $Z_{OL}^*$ ). Normally, these are stated as a function of frequency and are plotted on a Smith Chart and/or given in tabular form. It should be noted that  $Z_{in}$  and  $Z_{out}$  apply only for a specified set of operating conditions, i.e.,  $P_O$ ,  $V_{CC}$  and frequency. Both  $Z_{in}$  and  $Z_{out}$  of a device are determined in a similar way, i.e., place the D.U.T. in a tunable circuit and tune both input and output circuit elements to achieve maximum gain for the desired set of operating conditions. At maximum gain, D.U.T. impedances will be the conjugate of the input and output network impedances. Thus, terminate the input and output ports of the test circuit, remove the device and measure  $Z$  looking from the device — first, toward the input to obtain the conjugate of  $Z_{in}$  and, second, toward the output to obtain  $Z_{OL}$  which is the output load required to achieve maximum  $P_O$ .

A network analyzer is used in the actual measurement process to determine the complex reflection coefficient of the circuit using, typically, the edge of the package as a plane of reference. A typical measurement setup is shown in Figure 10. Figure 11 shows the special fixture used to obtain the short circuit reference while Figure 12 illustrates the adapter which allows the circuit impedance to be measured from the edge of the package.

Once the circuit designer knows  $Z_{IN}$  and  $Z_{OL}^*$  of the transistor as a function of frequency, he can use computer aided design programs to design L and C matching networks for his particular application.

The entire impedance measuring process is somewhat laborious and time consuming since it must be repeated for each frequency of interest. Note that the frequency range permitted for characterization is that over which the circuit will tune. For other frequencies, additional test circuits must be designed and constructed, which explains why it is sometimes difficult to get a semiconductor manufacturer to supply impedance data for special conditions of operation such as different frequencies, different power levels or different operating voltages.

### LOW POWER TRANSISTORS — Functional Characteristics

Most semiconductor manufacturers characterize low power RF transistors for linear amplifier and/or low noise amplifier applications. Selecting a proper low power transistor involves choosing one having an adequate current rating, in the "right" package and with gain and noise figure capability that meets the requirements of the intended application.

One of the most useful means of specifying a linear device is by means of scattering parameters, commonly referred to as S-Parameters which are in reality voltage reflection and transmission coefficients when the device is embedded into a 50 ohm system. See Figure 13.  $|S_{11}|$ , the magnitude



Figure 10. The HP Network Analyzer



Figure 11. Short Circuit Reference Fixture



Figure 12. Adapter Used To Measure  
Circuit Impedance From Package

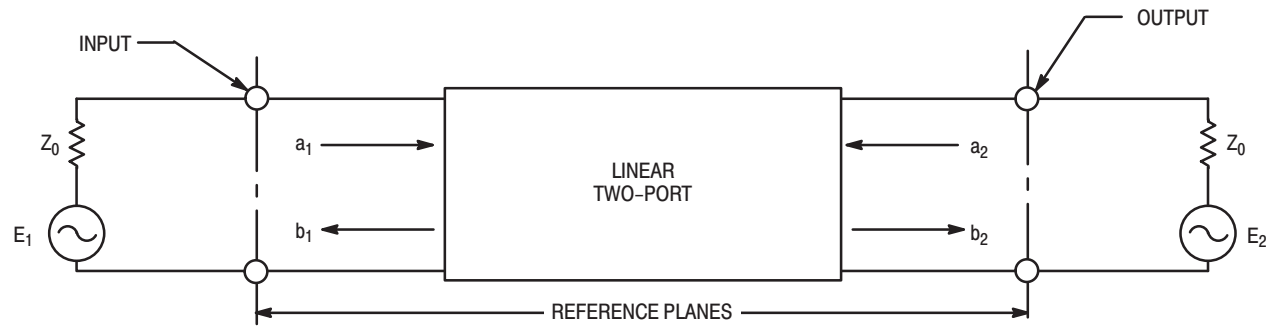

$$S_{11} \equiv \text{INPUT REFLECTION COEFFICIENT} = \left. \frac{b_1}{a_1} \right|_{a_2 = 0}$$

$$S_{22} \equiv \text{OUTPUT REFLECTION COEFFICIENT} = \left. \frac{b_2}{a_2} \right|_{a_1 = 0}$$

$$S_{21} \equiv \text{FORWARD TRANSMISSION COEFFICIENT} = \left. \frac{b_2}{a_1} \right|_{a_2 = 0}$$

$$S_{12} \equiv \text{REVERSE TRANSMISSION COEFFICIENT} = \left. \frac{b_1}{a_2} \right|_{a_1 = 0}$$

Figure 13. Two-Port S-Parameter Definitions

of the input reflection coefficient is directly related to input VSWR by the equation  $VSWR = (1 + |S_{11}|) / (1 - |S_{11}|)$ . Likewise,  $|S_{22}|$ , the magnitude of the output reflection coefficient is directly related to output VSWR.  $|S_{21}|^2$ , which is the square of the magnitude of the input-to-output transfer function, is also the power gain of the device. It is referred to on data sheets as "Insertion Gain." Note, however, that  $|S_{21}|^2$  is the power gain of the device when the source and load impedances are 50 ohms. An improvement in gain can always be achieved by matching the device's input and output impedances (which are almost always different from 50 ohms) to 50 ohms by means of matching networks. The larger the linear device, the lower the impedances and the greater is the need to use matching networks to achieve useful gain.

Another gain specification shown on low power data sheets is called "Associated Gain." The symbol used for Associated Gain is " $G_{NF}$ ." It is simply the gain of the device when matched for minimum noise figure. Yet another gain term is shown on some data sheets and it is called "Maximum Unilateral Gain." Its symbol is  $G_U \text{ max}$ . As you might expect,  $G_U \text{ max}$  is the gain achievable by the transistor when the input and output are conjugately matched for maximum power transfer (and  $S_{12} = 0$ ). One can derive a value for  $G_U \text{ max}$  using scattering parameters:

$$G_U \text{ max} = |S_{21}|^2 / \{(1 - |S_{11}|^2)(1 - |S_{22}|^2)\}.$$

Simply stated, this is the 50 ohm gain increased by a factor which represents matching the input and increased again by a factor which represents matching the output.

Many RF low power transistors are used as low noise amplifiers which has led to several transistor data sheet parameters related to noise figure.  $NF_{\min}$  is defined as the minimum noise figure that can be achieved with the transistor. To achieve this NF requires source impedance matching which is usually different from that required to achieve maximum gain. The design of a low noise amplifier, then, is always a compromise between gain and NF. A useful tool to aid in this compromise is a Smith Chart plot of constant

gain and Noise Figure contours which can be drawn for specific operating conditions — typically bias and frequency. A typical Smith Chart plot showing constant gain and NF contours is shown in Figure 14. These contours are circles which are either totally or partially complete within the confines of the Smith Chart. If the gain circles are contained entirely within the Smith Chart, then the device is unconditionally stable. If portions of the gain circles are outside the Smith Chart, then the device is considered to be "conditionally stable" and the device designer must concern himself with instabilities, particularly outside the normal frequency range of operation.

If the data sheet includes Noise Parameters, a value will be given for the optimum input reflection coefficient to achieve minimum noise figure. Its symbol is  $\Gamma_o$  or sometimes  $\Gamma_{\text{opt}}$ . But remember if you match this value of input reflection coefficient you are likely to have far less gain than is achievable by the transistor. The input reflection coefficient for maximum gain is normally called  $\Gamma_{\text{MS}}$ , while the output reflection coefficient for maximum gain is normally called  $\Gamma_{\text{ML}}$ .

Another important noise parameter is noise resistance which is given the symbol  $R_n$  and is expressed in ohms. Sometimes in tabular form, you may see this value normalized to 50 ohms in which case it is designated  $r_n$ . The significance of  $r_n$  can be seen in the formula below which determines noise figure NF of a transistor for any source reflection coefficient  $\Gamma_s$  if the three noise parameters —  $NF_{\min}$ ,  $r_n$  and  $\Gamma_o$  (the source resistance for minimum noise figure) — are known. Typical noise parameters taken from the MRF942 data sheet are shown in Figure 15.

$$NF = NF_{\min} + \{4r_n |\Gamma_s - \Gamma_o|^2\} / \{(1 - |\Gamma_s|^2) |1 + \Gamma_o|^2\}.$$

The locus of points for a given NF turns out to be a circle (the  $NF_{\min}$  circle being a point); thus, by choosing different values of NF one can plot a series of noise circles on the Smith Chart. Incidentally,  $r_n$  can be measured by measuring noise figure for  $\Gamma_s = 0$  and applying the equation stated above.



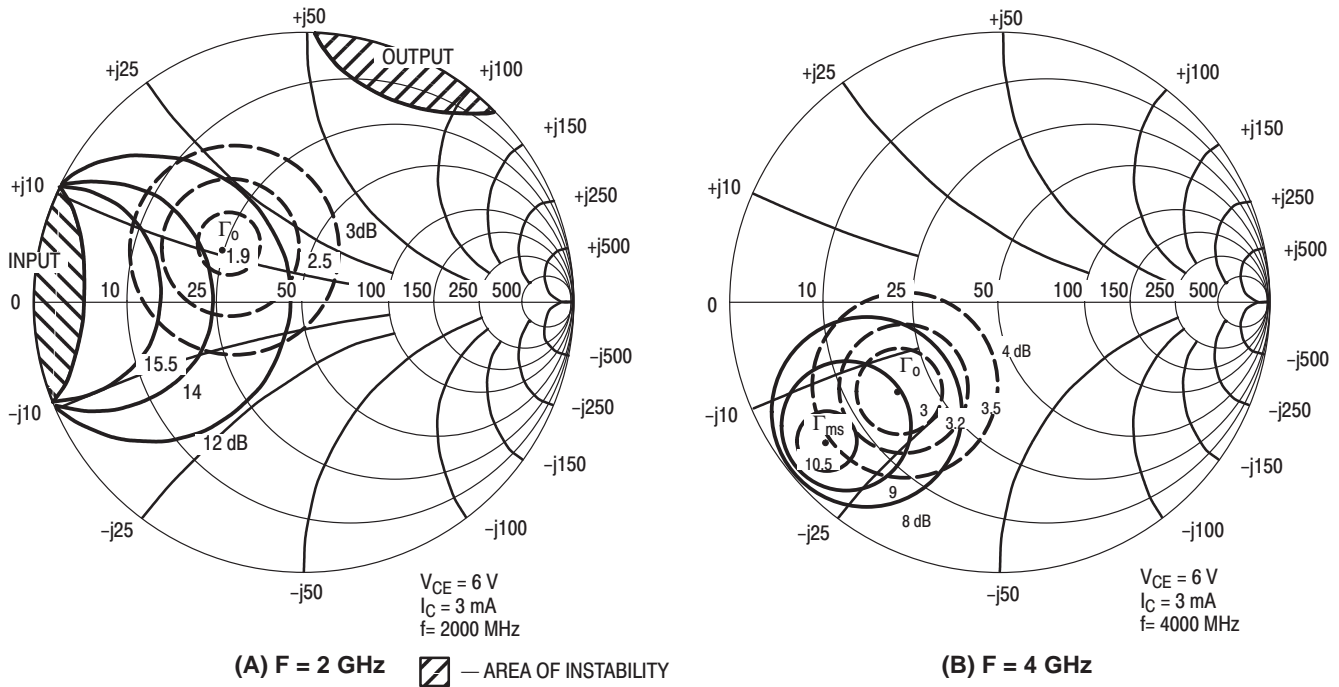

Figure 14. Gain and Noise Figure Contours

MRF942 $\angle$							
V <sub>CE</sub> (Vdc)	I <sub>C</sub> (mA)	f (MHz)	NF <sub>min</sub> (dB)	G <sub>NF</sub> (dB)	$\Gamma_o$ (MAG, ANG)	R <sub>N</sub> (ohms)	NF <sub>50 <math>\Omega</math></sub> (dB)
6	3	1000	1.3	16	.36 $\angle$ 94	17.5	1.7
		2000	2.0	11	.37 $\angle$ -145	15.5	2.6
		4000	2.9	8.0	.50 $\angle$ -134	21.5	4.3
	15	1000	2.1	19	.25 $\angle$ 150	13	2.6
		2000	2.7	14	.26 $\angle$ -173	16.5	3.1
		4000	4.3	9.0	.48 $\angle$ -96	47	5.4

Figure 15. Typical Noise Parameters

A parameter found on most RF low power data sheets is commonly called the current gain–bandwidth product. Its symbol is  $f_t$ . Sometimes it is referred to as the cutoff frequency because it is generally thought to be the product of low frequency current gain and the frequency at which the current gain becomes unity. While this is not precisely true (see Figure 16), it is close enough for practical purposes. And it is true that  $f_t$  is an excellent figure–of–merit which becomes useful in comparing devices for gain and noise figure capability. High values of  $f_t$  are normally required to achieve higher gain at higher frequencies, other factors being equal. To the device designer, high  $f_t$  mean decreased spacings between emitter and base diffusions and it means shallower diffusions — things which are more difficult to achieve in making an RF transistor.

The complete RF low power transistor data sheet will include a plot of  $f_t$  versus collector current. Such a curve (as shown in Figure 17) will increase with current, flatten and then begin to decrease as  $I_C$  increases thereby revealing useful information about the optimum current with which to achieve maximum device gain.

Another group of characteristics associated with linear (or Class “A”) transistors has to do with the degree to which the device is linear. Most common are terms such as “P<sub>o</sub>, 1 dB Gain Compression Point” and “3rd Order Intercept Point” (or ITO as it is sometimes called). More will be said about non–linearities and distortion measurements in the section about Linear Amplifiers; however, suffice it to be said now that “P<sub>o</sub>, 1 dB Gain Compression Point” is simply the output power at which the input power has a gain associated with it that is 1 dB less than the low power gain. In other words, the device is beginning to go into “saturation” which is a condition where increases in input power fail to realize comparable increases in output power. The concept of gain compression is illustrated in Figure 18.

The importance of the “1 dB Gain Compression Point” is that this is generally accepted as the limit of non–linearity that is tolerable in a “linear” amplifier and leads one to the dynamic range of the low power amplifier. On the low end of dynamic range is the limit imposed by noise, and on the high end of dynamic range is the limit imposed by “gain compression.”

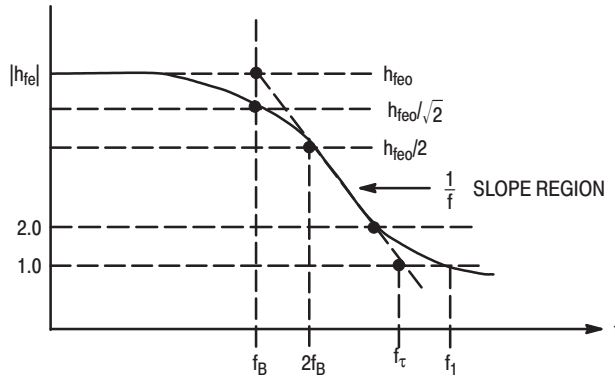

WHERE  $|h_{fe}|$  = MAGNITUDE OF SMALL-SIGNAL COMMON-EMITTER (CE) SHORT-CIRCUIT (SC) CURRENT GAIN,  $h_{fe}$

$h_{feo}$  = LOW-FREQUENCY VALUE OF  $h_{fe}$

$f_B$  = 3 dB CUTOFF FREQUENCY FOR CE, SC CURRENT GAIN

$f_\tau$  = TRANSITION FREQUENCY =  $|h_{fe}| \cdot f_{MEAS}$

WHERE  $f_{MEAS}$  = FREQUENCY OF MEASUREMENT  
(NOTE:  $2 \leq |h_{fe}| \leq \frac{h_{feo}}{2}$ )

$f_1$  = FREQUENCY AT WHICH  $|h_{fe}| = 1$

Figure 16. Small Signal Current Gain versus Frequency

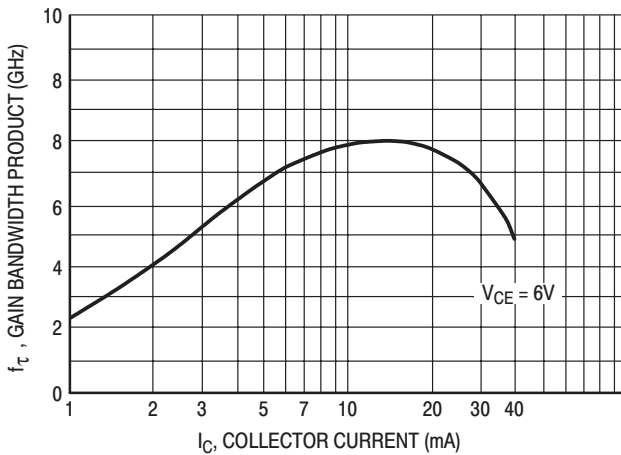

Figure 17. Gain-Bandwidth Product versus Collector Current

**LINEAR MODULES — Functional Characteristics**

Let's turn now to amplifiers and examine some specifications encountered that are unique to specific applications. Amplifiers intended for cable television applications are selected to have the desired gain and distortion characteristics compatible with the cable network requirements. They are linear amplifiers consisting of 2 or more stages of gain each using a push-pull cascode configuration. Remember that a cascode stage is one consisting of 2 transistors in which a common emitter stage drives a common base stage. A basic circuit configuration is shown in Figure 19. Most operate from a standard voltage of 24 volts and are packaged in an industry standard configuration shown in Figure 20. Because they are used

to "boost" the RF signals that have been attenuated by the losses in long lengths of coaxial cable (the losses of which increase with frequency), their gain characteristics as a function of frequency are very important. These are defined by the specifications of "slope" and "flatness" over the frequency band of interest. Slope is defined simply as the difference in gain at the high and low end of the frequency band of the amplifier. Flatness, on the other hand, is defined as the deviation (at any frequency in the band) from an ideal gain which is determined theoretically by a universal cable loss function. Motorola normally measures the peak-to-valley (high-to-low) variations in gain across the frequency band, but specifies the flatness as a "plus, minus" quantity because it is assumed that cable television system designers have the capability of adjusting overall gain level.

The frequency band requirements of a CATV amplifier are determined by the number of channels used in the CATV system. Each channel requires 6 MHz bandwidth (to handle conventional color TV signals). Currently available models in the industry have bandwidths extending from 40 to 550 MHz and will accommodate up to 77 channels, the center frequencies of which are determined by industry standard frequency allocations. New state-of-the-art CATV amplifiers are currently being developed to operate at frequencies up to 1 GHz and 152 channels.

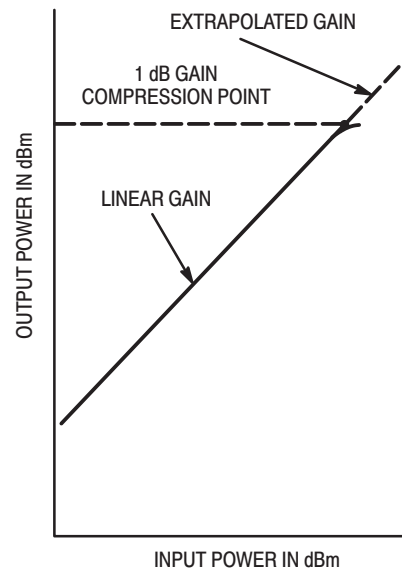

Figure 18. Linear Gain and 1 dB Compression Point

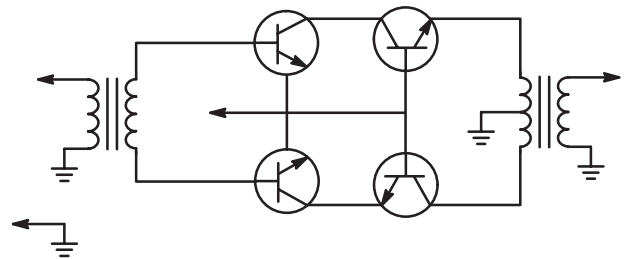

Figure 19. Basic CATV Amplifier

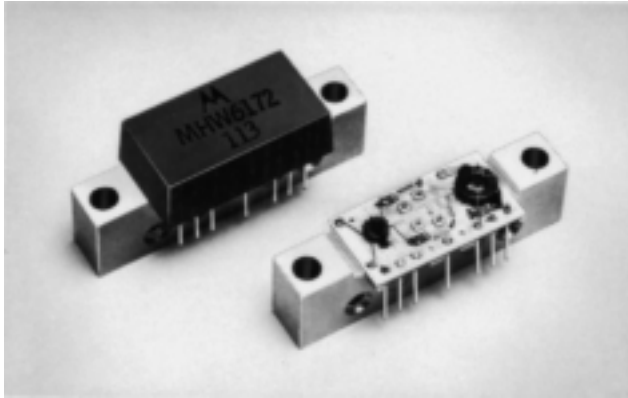

Figure 20. Standard CATV Package (Case 714-04)

Because CATV amplifiers must amplify TV signals and they must handle many channels simultaneously, these amplifiers must be extremely linear. The more linear, the less distortion that is added to the signal and, thus, the better is the quality of the TV picture being viewed. Distortion is generally specified in 3 conventional ways — 2nd Order Intermodulation Distortion (IMD), Cross Modulation Distortion (XMD) and Composite Triple Beat (CTB). In order to better understand what these terms mean, a few words need to be said about distortion in general.

First, let's consider a perfectly linear amplifier. The output signal is exactly the same as the input except for a constant gain factor. Unfortunately, transistor amplifiers are, even under the best of circumstances, not perfectly linear. If one were to write a transfer function for a transistor amplifier, a typical input-output curve for which is shown in Figure 21, he would find the region near zero to be one best represented by "squared" terms, i.e., the output is proportional to the square of the input. And the region near saturation, i.e., where the amplifier produces less incremental output for incremental increases in input is best represented by "cubed" terms, i.e., the output is proportional to the cube of the input. A mathematically rigorous analysis of the transfer function of an amplifier would include an infinite number of higher order terms. However, an excellent approximation is obtained by considering the first three terms, i.e., make the assumption we can write

$$F(x) = k_1x + k_2x^2 + k_3x^3,$$

where F is the output signal and x is the input signal.  $k_1$ ,  $k_2$  and  $k_3$  are constants that represent the transfer function (gain) for the first, second and third order terms.

Now consider a relatively simple input signal consisting of 3 frequencies each having a different amplitude A, B or C. (In the case of CATV amplifiers, there could be 50–60 channels each having a carrier frequency and associated modulation frequencies spread over a bandwidth approaching 6 MHz.) The input signal x then equals  $A\cos\omega_1t + A\cos\omega_2t + A\cos\omega_3t$ . For simplicity, let's write this as  $A\cos a + B\cos b + C\cos c$ , where  $a = \omega_1t$ ,  $b = \omega_2t$  and  $c = \omega_3t$ . If we apply this input signal to the transfer function and calculate F(x), we will find many terms involving x,  $x^2$  and  $x^3$ . The "x" terms represent the "perfect", linear amplification of the input signal. Terms involving  $x^2$  when analyzed on a frequency basis result in signal components at two times the frequencies of  $f_1$ ,  $f_2$  and  $f_3$ . Also created by  $x^2$  terms are signal components at sums and difference frequencies of

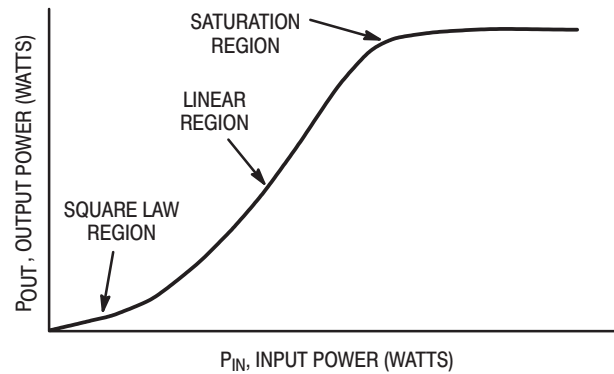

Figure 21. Transfer Function for Typical

all combinations of  $a(f_1)$ ,  $b(f_2)$  and  $c(f_3)$ . These are called 2nd order intermodulation components. Likewise, the terms involving  $x^3$  result in frequency components at three times the frequencies of  $f_1$ ,  $f_2$  and  $f_3$ . And there are also frequency components at sum and difference frequencies (these are called 3rd order IMD). But in addition there are frequency components at  $a +, - b +, - c$ . These are called "triple beat" terms. And this is not all! A close examination reveals additional amplitude components at the original frequencies of a, b and c. These terms can both "enhance" gain (expansion) or "reduce" gain (compression). The amplitude of these expansion and compression terms are such that we can divide the group of terms into two categories — "self-expansion/compression" and "cross-expansion/compression." Self-expansion/compression terms have amplitudes determined by the amplitude of a single frequency while cross-expansion/compression terms have amplitudes determined by the amplitudes of two frequencies. A summary of the terms that exist in this "simple" example is given in Table 1.

Before going into an explanation of the tests performed on linear amplifiers such as CATV amplifiers, it is appropriate to review a concept called "intercept point." It can be shown mathematically that 2nd order distortion products have amplitudes that are directly proportional to the square of the input signal level, while 3rd order distortion products have amplitudes that are proportional to the cube of the input signal level. Hence, it can be concluded that a plot of each response on a log-log scale (or dB/dB scale) will be a straight line with a slope corresponding to the order of the response. Fundamental responses will have a slope of 1, the 2nd order responses will have a slope of 2 and the 3rd order responses a slope of 3. Note that the difference between fundamental and 2nd order is a slope of 1 and between fundamental and 3rd order is a slope of 2. That is to say, for 2nd order distortion, a 1 dB change in signal level results in a 1 dB change in 2nd order distortion; however, a 1 dB change in signal level results in a 2 dB change in 3rd order distortion. This is shown graphically in Figure 22. Using the curves of Figure 22, if the output level is 0 dBm, 2nd order distortion is at -30 dBc and 3rd order distortion is at -60 dBc. If we change the output level to -10 dBm, then 2nd order distortion should improve to -40 dBc (-50dBm) but 3rd order distortion will improve to -80 dBc (-90 dBm). Thus we see that a 10 dB decrease in signal has improved 2nd order distortion by 10 dB and 3rd order distortion has improved by 20 dB.

**Table 1.**  
**Terms in Output for Three Frequency Signal at Input**

FIRST ORDER COMPONENTS	COMMENTS
$k_1A \cos a + k_1B \cos b + k_1C \cos c$	Linear Amplification
SECOND ORDER DISTORTION COMPONENTS	
$k_2A^2/2 + k_2B^2/2 + k_2C^2/2$	3 DC components
$k_2AB \cos(a+,-b) + k_2AC \cos(a+,-c) + k_2BC \cos(b+,-c)$	6 Sum & Difference Beats
$k_2A^2/2 \cos 2a + k_2B^2/2 \cos 2b + k_2C^2/2 \cos 2c$	3–2nd Harmonic Components
THIRD ORDER DISTORTION COMPONENTS	
$k_3A^3/4 \cos 3(a) + k_3B^3/4 \cos 3(b) + k_3C^3/4 \cos 3(c)$	3–3rd Harmonic Components
$3k_3A^2B/4 \cos(2a+,-b) + 3k_3A^2C/4 \cos(2a+,-c) + 3k_3B^2A/4 \cos(2b+,-a) + 3k_3B^2C/4 \cos(2b+,-c) + 3k_3C^2A/4 \cos(2c+,-a) + 3k_3C^2B/4 \cos(2c+,-b)$	12 Intermodulation Beats
$3k_3ABC/2 \cos(a+,-b+,-c)$	4 Triple Beat Components
$3k_3A^3/4 \cos(a) + 3k_3B^3/4 \cos(b) + 3k_3C^3/4 \cos(c)$	3 Self Compression ( $k_3$ is +) or Self Expansion ( $k_3$ is –)
$3k_3AB^2/2 \cos(a) + 3k_3AC^2/2 \cos(a) + 3k_3BA^2/2 \cos(b) + 3k_3BC^2/2 \cos(b) + 3k_3CA^2/2 \cos(c) + 3k_3CB^2/2 \cos(c)$	6 Cross Compression ( $k_3$ is +) or Cross Expansion ( $k_3$ is –)

Now for “intercept point.” We define the “intercept point” as the point on the plot of fundamental response and 2nd (or 3rd) order response where the two straight lines intercept each other. It is also that value of signal (hypothetical) at which the level of distortion would equal the initial signal level. For example, if at our point of measurement, the 2nd order distortion is –40 dBc and the signal level is –10 dBm; then the 2nd order intercept point is 40 dB above –10 dBm or +30 dBm. Note in Figure 22 that +30 dBm is the value of output signal at which the fundamental and 2nd order response lines cross. The beauty of the concept of “intercept point” is that once you know the intercept point, you can determine the value of distortion for any signal level — provided you are in a region of operation governed by the mathematical relationships stated, which typically means IMD’s greater than 60 dB below the carrier.

Likewise to determine 3rd order intercept point, one must measure 3rd order distortion at a known signal level. Then take half the value of the distortion (expressed in dBc) and add to the signal level. For example, if the signal level is +10 dBm and the 3rd order distortion is –40 dBc, the 3rd order intercept point is the same as the 2nd order intercept point or 10 dBm + 20 dB = 30 dBm. Both 2nd order and 3rd order intercept points are illustrated in Figure 22 using the values assumed in the preceding examples. Note, also, that in general the intercept points for 2nd and 3rd order distortion will be different because the non-linearities that create second order distortion are usually different from those that create third order distortion. However, even in this situation the concept of intercept point is still valid; the slopes of the responses are still 1, 2 and 3 respectively and all that needs to be done is to specify a 2nd order intercept point different from the 3rd order intercept point.

With this background information, let’s turn to specific distortion specifications listed on many RF linear amplifier data sheets. If the amplifiers are for use in cable television distribution systems, as previously stated, it is common practice to specify Second Order Intermodulation Distortion, Cross Modulation Distortion and Composite Triple Beat. We will examine these one at a time. First, consider Second Order Intermodulation Distortion (IMD). Remember these are unwanted signals created by the sums and differences of any two frequencies present in the amplifier. IMD is normally specified at a given signal output level and involves 3 channels — two for input frequencies and one to measure the resulting distortion frequency. The channel combinations are standardized in the industry but selected in a manner that typically gives a worst case condition for the 2nd order distortion results. An actual measurement consists of creating output signals (unmodulated) in the first two channels listed and looking for the distortion products that appear in the 3rd channel. If one wishes to predict the 2nd order IMD that would occur if the signals were stronger (or weaker), it is only necessary to remember the 1:1 relationship that led to a 2nd Order Intercept Point. In other words, if the specification guarantees an IMD of –68 dB Max. for a  $V_{out} = +46$  dBmV per channel, then one would expect an IMD of –64 dB Max for a  $V_{out} = +50$  dBmV per channel, etc.

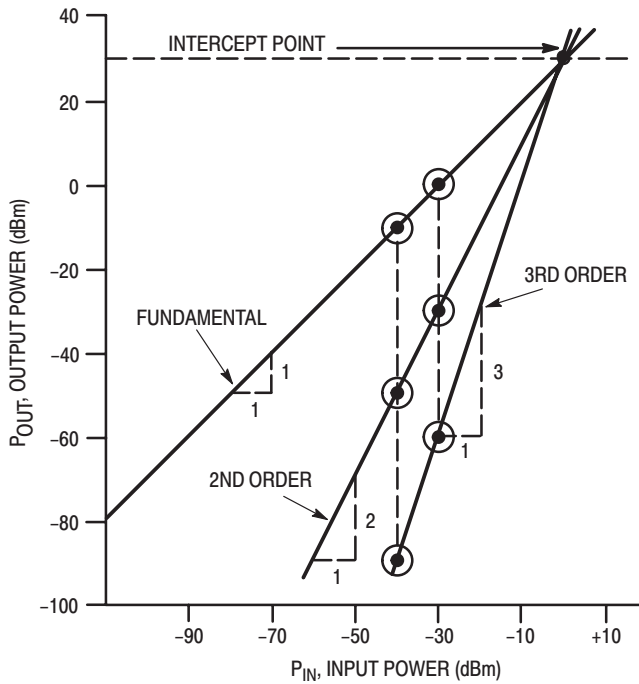

**Figure 22. Amplifier Response Curves**

Cross Modulation Distortion (XMD) is a result of the cross-compression and cross-expansion terms generated by the third order non-linearity in the amplifier's input-output transfer function. In general, the XMD test is a measurement of the presence of modulation on an unmodulated carrier caused by the distortion contribution of a large number of modulated carriers. The actual measurement consists of modulating each carrier with 100% square wave modulation at 15.75 kHz. Then the modulation is removed from one channel and the presence of residual modulation is measured with an amplitude modulation (AM) detector such as the commercially available Matrix RX12 distortion analyzer. Power levels and frequency relationships present in the XMD test are shown in Figure 23.

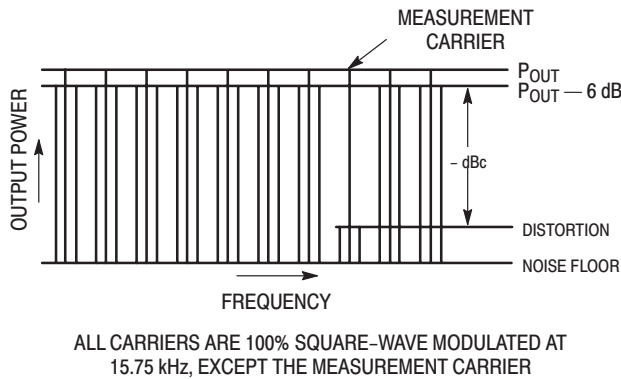

Figure 23. Frequency — Power Relationships for XMD

Composite Triple Beat (CTB) is quite similar to XMD except all channel frequencies are set to a specified output level without modulation. Then one channel frequency is removed and the presence of signal at that frequency is measured. The signals existing in the "off" channel are a result of triple beats (the mixing of 3 signals) among the host of carrier frequencies that are present in the amplifier. A graphical representation of the CTB test is shown in Figure 24.

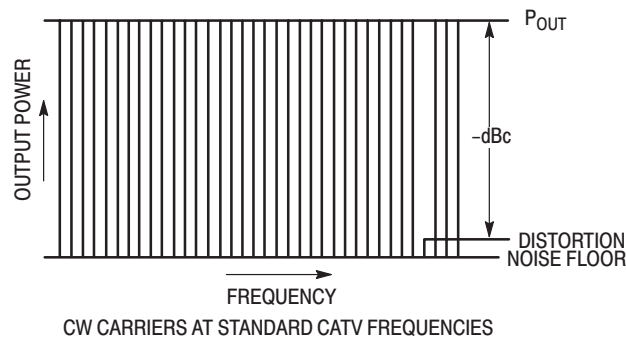

Figure 24. Frequency — Power Relationships for CTB

European cable television systems usually invoke an additional specification for linear amplifiers which is called the DIN test. DIN is a German standard meaning Deutsche Industrie Norm (German Industrial Standard) and the standard that applies for CATV amplifiers is #45004B. DIN45004B is a special case of a three channel triple beat measurement in which the signal levels are adjusted to produce a -60 dBc distortion level. An additional difference

from normal triple beat measurements is the fact that the levels are different for the three combining signals. If we call the four frequencies involved in the measurement  $F$ ,  $F_1$ ,  $F_2$  and  $F_m$ , then  $F$  is set at the required output level that, along with  $F_1$  and  $F_2$  lead to a distortion level 60 dB below the level of  $F$ , and  $F_1$  and  $F_2$  are adjusted to a level 6 dB below the level of  $F$ . Distortion is measured at the frequency  $F_m$ . Frequency relationships (used by Motorola) between  $F$ ,  $F_1$ ,  $F_2$  and  $F_m$  are as follows:  $F_1 = F - 18$  MHz;  $F_2 = F - 12$  MHz and  $F_m = F + F_2 - F_1$ . Figure 25 illustrates the frequency and power level relationships that exist in the DIN test.

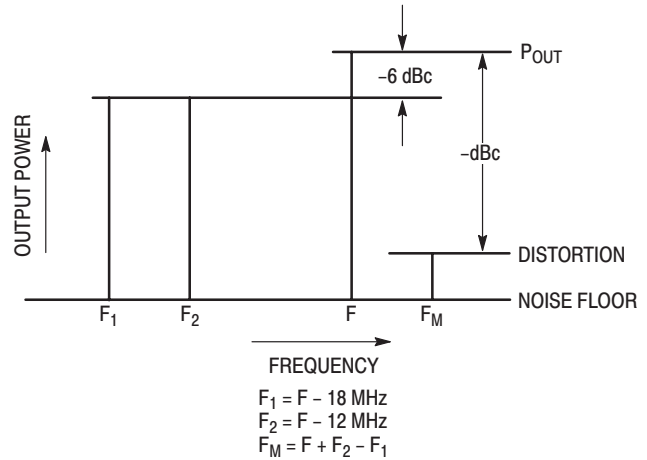

Figure 25. Frequency — Power Relationships for DIN45004B

Linear amplifiers aimed at television transmitter applications will generally have another distortion test involving 3 frequencies. Basically it is another 3rd order intermodulation test with power levels and frequencies that simulate a TV signal. Relative power levels and frequencies are shown in Figure 26.

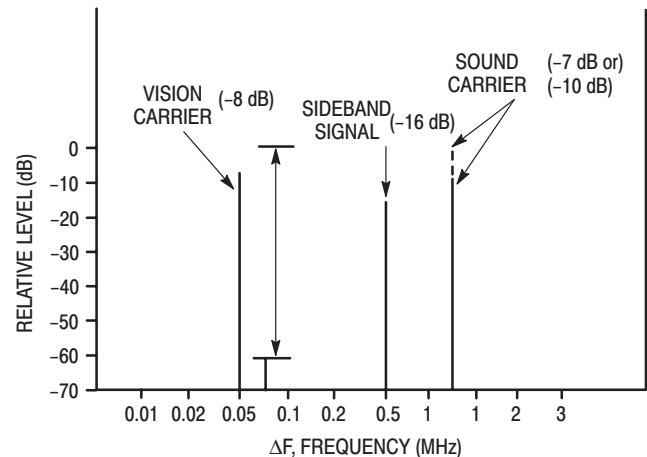

Figure 26. 3rd Order IMD Test for TV

Thermal resistance ratings of CATV modules (as well as Power modules described in the next section) are, perhaps, conspicuous by their absence. Because the amplifiers have several heat sources that are contained within the amplifier, it is necessary for the user to provide sufficient heat sinking to the case of the amplifier such that the operating case temperature never exceeds its maximum rating. Actual power dissipation can be determined by considering the

operating voltage and the maximum current rating of the device. RF power output of most CATV modules is at most a few milliwatts which means that most of the power consumed by the module is dissipated in the form of heat. Typically this power dissipation runs in the range of 5 watts for conventional modules such as the MHW5122A but can increase to 10 watts for a power doubler such as the MHW5185.

Because linear (and power) modules have inputs and outputs that are matched to standard system impedances (75 ohms for CATV amplifiers and 50 ohms for power amplifiers), test circuits and fixtures are generally less important than for discrete devices. Basically test fixtures for modules are simply means of making RF and DC power connections to the module being tested. It is important if you build your own test fixture that you carefully decouple the DC power lines and that you provide adequate heat sinking for the device under test (D.U.T.). However, if the fixture is for linear modules involving low values of input and output VSWR, then it is extremely important, for accuracy, that the input and output networks (lines and connectors) be designed to exhibit return losses greater than 35 dB. Motorola modifies the RF connectors used in the fixture and, then, calibrates their fixtures to be sure that the fixture does not introduce errors in measuring module return loss.

#### POWER MODULES — Functional Characteristics

Power modules are generally used to amplify the transmit signals in a 2-way radio to the desired level for radiation by the antenna. They consist of several stages of amplification (usually common emitter, Class C except for some low level stages that are Class A) combined in a hybrid integrated assembly with nominally 50 ohm RF input and output impedances. Selection of a module involves choosing one having the proper operating voltage, frequency range, output power, overall gain and mechanical form factor suitable for a particular application.

Power modules for mobile and portable radios also have unique specifications related to their applications. One of the most significant is that of stability. The stability of a module is affected not only by its design but also by many external factors such as load and source impedances, by the value of supply voltage and by the amount of RF input signal. External factors influencing stability are highlighted in Figure 27. Combinations of these factors over a range of values for each factor must be considered to be certain the module will remain stable under typical conditions of operation. The greater the range of values for which stability is guaranteed, the more stable is the module. Of particular importance is the degree of load mismatch which can be tolerated as evidenced by the stated value of load VSWR (the larger the value, the better). Stability specifications are generally evaluated thoroughly during the pre-production phase and then guaranteed but not tested on a production basis.

Efficiency is becoming an increasingly important specification particularly in modules for portable radio applications. The correct way to specify efficiency is to divide the RF power out of the module by the total RF and DC powers that are put into the module by the total DC power consumed by the module. Efficiency is generally specified at rated output power because it will decrease when the module is operated at lower power levels. Be careful that the specification includes the current supplied for biasing and

for stages other than the output stage. Overlooking these currents (and the DC power they use) results in an artificially high value for module efficiency.

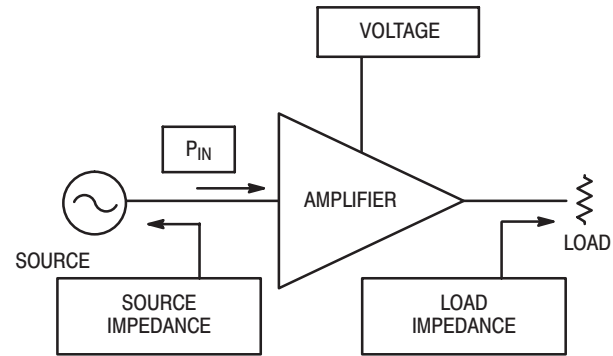

Figure 27. External Factors Affecting Stability

Most power module data sheets include a curve of output power versus temperature. Some modules specify this "power slump" in terms of a minimum power output at a stated maximum temperature; others state the maximum permissible decrease in power (in dB) referenced to rated power output. It is important to note the temperature range and the other conditions applied to the specification before passing judgement on this specification.

Generally power modules, like linear modules, do not have thermal resistance specified from die to heatsink. For multiple stage modules, there would need to be a specific thermal resistance from heatsink to each die. Thermal design of the module will take care of internal temperature rises provided the user adheres to the maximum rating attached to the operating case temperature range. This is an extremely important specification, particularly at the high temperature end because of two factors. First, exceeding the maximum case temperature can result in die temperatures that exceed 200°C. This, in turn, will lead as a minimum to decreased operating life and as a maximum to catastrophic failure as a result of thermal runaway destroying the die. Second, hybrid modules have components that are normally attached to a circuit board and the circuit board attached to the flange with a low temperature solder which may become liquid at temperatures as low as 125°C. Again, the power to be dissipated can be determined by considering the RF output power and the minimum efficiency of the module. For example, for the MHW607, output power is 7 watts and input power is 1 mW; efficiency is 40% minimum. Thus the DC power input must be  $7/0.4 = 17.5$  watts. It follows that power dissipation would be  $17.5 - 7 = 10.5$  watts worst case.

Storage temperature maximum values are also important as a result of the melting temperatures of solder used in assembly of the modules. Another factor is the epoxy seal used to attach the cover to the flange. It is a material similar to that used in attaching caps for discrete transistors and, as stated earlier, is known to deteriorate at temperatures greater than 150°C.

Modules designed for use in cellular radios require wide dynamic range control of output power. Most modules provide for gain control by adjusting the gain of one (or two) stages by means of changing the voltage applied to that stage(s). Usually the control is to vary the collector voltage applied to an intermediate stage. A maximum voltage is stated on the data sheet to limit the control voltage to a safe

value. This form of gain control is quite sensitive to small changes in control voltage as is evidenced by viewing the output power versus control voltage curves provided for the user (an example is shown in Figure 28). An alternative control procedure which uses much less current is to vary the base-to-emitter voltage of the input stages (which are generally class A) as illustrated in Figure 29. This is of particular significance in portables because of the power dissipated in the control network external to the module.

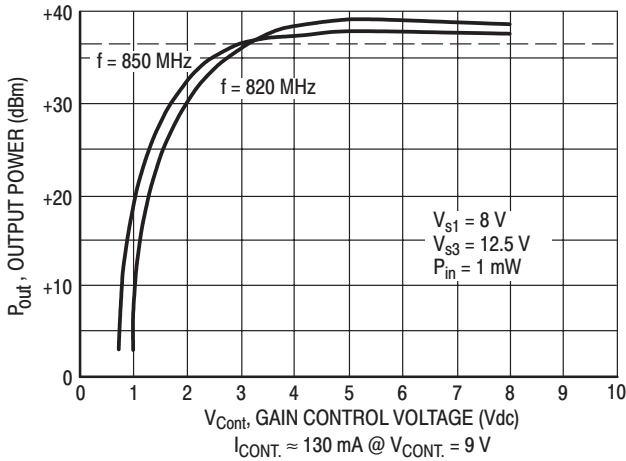

Figure 28. Output Power versus Gain Control Voltage

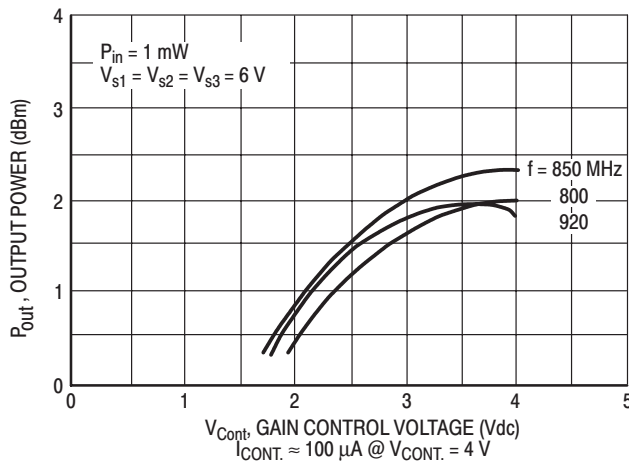

Figure 29. Output Power versus Control Voltage

While not stated on most data sheets, it is always possible to control the output power of the module by controlling the RF input signal. Normally this is done by means of a PIN diode attenuator. Controlling the RF input signal allows the module to operate at optimum gain conditions regardless of output power. Under these conditions, the module will produce less sideband noise, particularly for small values of output power, when compared to the situation that arises from gain control by gain reduction within the module.

Noise produced by a power module becomes significant in a duplexed radio in the frequency band of the received signal (see Figure 30). A specification becoming more prominent, therefore, in power modules is one that controls the maximum noise power in a specified frequency band a given distance from the transmit frequency. Caution must be taken in making measurements of noise power. Because the levels are generally very low (-85 dBm), one must be

assured of a frequency source driving the module that has extremely low noise. Any noise on the input signal is amplified by the module and cannot be discerned from noise generated within the module. Another precaution is to be sure that the noise floor of the spectrum analyzer used to measure the noise power is at least 10 dB below the level to be measured.

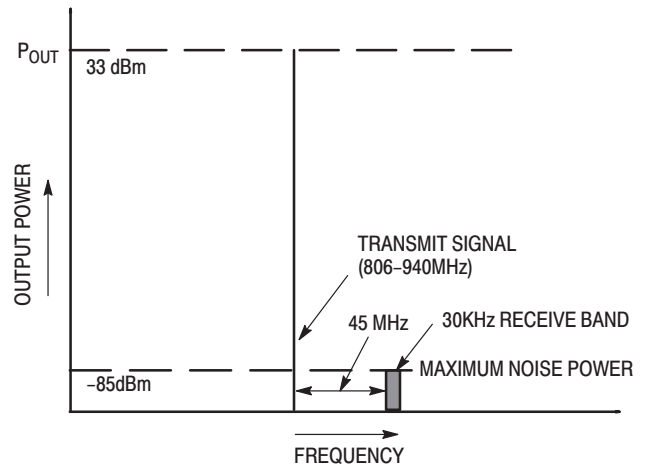

Figure 30. Noise Power in Receive Band

DATA SHEETS OF THE FUTURE

World class data sheets in the next few years will tend to provide more and more information about characteristics of the RF device; information that will be directly applicable by the engineer in using the device. Semiconductor manufacturers such as Motorola will provide statistical data about parameters showing mean values and sigma deviations. For discrete devices, there will be additional data for computer aided circuit design such as SPICE constants. The use of typical values will become more widespread; and, the availability of statistical data and the major efforts to make more consistent products (six-sigma quality) will increase the usefulness of these values.

SUMMARY

Understanding data sheet specifications and what they mean can be a major asset to the circuit designer as he goes about selecting and using RF semiconductors for his specific application. This paper has emphasized some unique data sheet parameters of RF transistors and amplifiers and has explained what these mean from the semiconductor manufacturer's point-of-view. It is hoped this effort will help the circuit engineer make his selection and use of RF semiconductors more efficient and effective.

The RF transistor and the amplifiers made with RF transistors are unusually complex semiconductor products and difficult to fully characterize. Not all information about RF device characteristics has been explained in this paper. Nor can all be covered in a data sheet. The circuit design engineer should contact the device manufacturer for more detailed information whenever it is appropriate. Most if not all current manufacturers of RF transistors and amplifiers have extensive applications support for the express purpose of assisting the circuit designer whenever and wherever assistance is needed.

Motorola reserves the right to make changes without further notice to any products herein. Motorola makes no warranty, representation or guarantee regarding the suitability of its products for any particular purpose, nor does Motorola assume any liability arising out of the application or use of any product or circuit, and specifically disclaims any and all liability, including without limitation consequential or incidental damages. "Typical" parameters can and do vary in different applications. All operating parameters, including "Typicals" must be validated for each customer application by customer's technical experts. Motorola does not convey any license under its patent rights nor the rights of others. Motorola products are not designed, intended, or authorized for use as components in systems intended for surgical implant into the body, or other applications intended to support or sustain life, or for any other application in which the failure of the Motorola product could create a situation where personal injury or death may occur. Should Buyer purchase or use Motorola products for any such unintended or unauthorized application, Buyer shall indemnify and hold Motorola and its officers, employees, subsidiaries, affiliates, and distributors harmless against all claims, costs, damages, and expenses, and reasonable attorney fees arising out of, directly or indirectly, any claim of personal injury or death associated with such unintended or unauthorized use, even if such claim alleges that Motorola was negligent regarding the design or manufacture of the part. Motorola and  are registered trademarks of Motorola, Inc. Motorola, Inc. is an Equal Opportunity/Affirmative Action Employer.

**Literature Distribution Centers:**

USA: Motorola Literature Distribution; P.O. Box 20912; Phoenix, Arizona 85036.

EUROPE: Motorola Ltd.; European Literature Centre; 88 Tanners Drive, Blakelands, Milton Keynes, MK14 5BP, England.

JAPAN: Nippon Motorola Ltd.; 4-32-1, Nishi-Gotanda, Shinagawa-ku, Tokyo 141, Japan.

ASIA PACIFIC: Motorola Semiconductors H.K. Ltd.; Silicon Harbour Center, No. 2 Dai King Street, Tai Po Industrial Estate, Tai Po, N.T., Hong Kong.

**MOTOROLA**

**For More Information On This Product,**  
**Go to: [www.freescale.com](http://www.freescale.com)**

AN1107/D